

www.mbsm.pro , Some Funny Electric pictures part1

written by mahdi miled | 12 August 2018

www.mbsm.pro , Some Funny Electric pictures part1

mbsm-dot-pro-picture-electric -funny1.jpg (37 KB)



PictureS Mbsm Dot Pro : www.mbsm.pro

mbsm-dot-pro-picture-electric -funny1.jpg (47 KB)



mbsm-dot-pro-picture-electric -funny2.jpg (63 KB)



PictureS Mbsm Dot Pro : www.mbsm.pro

mbsm-dot-pro-picture-electric -funny2.jpg (73 KB)



mbsm-dot-pro-picture-electric -funny3.jpg (121 KB)



mbsm-dot-pro-picture-electric -funny3.jpg (124 KB)



mbsm-dot-pro-picture-electric -funny4.jpg (145 KB)



mbsm-dot-pro-picture-electric -funny4.jpg (133 KB)



mbsm-dot-pro-picture-electric -funny5.jpg (117 KB)



mbsm-dot-pro-picture-electric -funny5.jpg (129 KB)



mbsm-dot-pro-picture-electric -funny6.jpg (23 KB)



mbsm-dot-pro-picture-electric -funny6.jpg (27 KB)



mbsm-dot-pro-picture-electric -funny7.jpg (62 KB)



mbsm-dot-pro-picture-electric -funny7.jpg (72 KB)



mbsm-dot-pro-picture-electric -funny8.jpg (31 KB)



mbsm-dot-pro-picture-electric -funny8.jpg (33 KB)



www.mbsm.pro , Quelle est la différence entre le SDS PLUS et le SDS MAX ?

written by mahdi miled | 12 August 2018

Lorsque vous choisissez un outil, vous aurez donc le choix entre la fixation par mandrin classique (avec ou sans clé de serrage) et par mandrin SDS avec les variantes SDS PLUS et SDS MAX.

Attention, vos accessoires classiques ne seront pas adaptés aux système SDS et inversement ! Le système SDS accueille en effet des mèches/forets avec cannelures qui s'encastrent dans le mandrin et permettent une fixation plus fiable que les forets classiques qui finissent par «glisser dans le mandrin», particulièrement lors de gros travaux (forage / percussion sur de la pierre)

**www.mbsm.pro , Pompe
hydrauliques volumétriques
double à engrenage interne à
gérotor (orifices
indépendants) .**

written by Lilianne | 12 August 2018



PictureS Mbsm Dot Pro : www.mbsm.pro

Il existe plusieurs types de pompes hydrauliques

volumétriques.

A chaque type de pompe correspondent une nature et un agencement particulier des pièces mobiles internes.



Quel qu'en soit le type, une pompe hydraulique remplit essentiellement le même rôle, c'est celui de faire circuler un liquide.

Le fonctionnement de tous les types de pompes repose sur le même principe:

- Lorsque la pompe est mise en marche par l'intermédiaire de **sa source motrice**, les pièces **mobiles internes se déplacent et attirent l'air** qui se trouve dans la canalisation du côté de **l'admission de la pompe**.
- Ce mouvement des pièces internes crée **un vide partiel**.
- La pression atmosphérique agit alors sur la surface du liquide contenu dans le réservoir en poussant **ce fluide vers l'admission de la pompe**.
- Le fluide est ensuite entraîné par les pièces mobiles et finalement refoulé vers le système hydraulique à actionner.

Ce cours porte sur les différents types de pompes hydrauliques volumétriques:

- Pompes à engrenage,
- pompes à palettes,
- pompes à pistons.

Vous verrez quelles sont les pièces mobiles qui caractérisent ces divers types de pompes ainsi que l'interaction de ces composants.

Pompes à engrenage

Les pompes hydrauliques volumétriques à engrenage sont de constitution simple parce qu'elles ne possèdent que peu de pièces mobiles internes.

Ce type de pompe:

- présente l'avantage d'être celui le **moins coûteux**.
- offre un **rendement** volumétrique **peu élevé**.

- est à **cyindrée fixe**.

D'une manière générale, les pompes à engrenage présentent deux inconvénients :

1. lorsqu'elles sont sollicitées à de faibles débits, ceux-ci sont irréguliers avec pour conséquence **d'agir sur le niveau sonore**.
2. à cause des fuites internes affectant le rendement volumique, elles ne peuvent être utilisées en cas de hautes pressions, ce qui entraîne des pressions de refoulement n'excédant pas 250 bars.

Ces pompes sont à débit constant de par leur conception.

Comme le nom l'indique, les pompes à engrenage renferment deux roues dentées qui s'engrènt (s'engagent) l'une dans l'autre.

Il existe deux catégories de pompes à engrenage :

1. les pompes à engrenage externe ;
2. les pompes à engrenage interne.

Pompes à engrenage externe: principe

Les pompes à engrenage externe tirent leur nom de la position de leurs roues dentées.

Ces roues sont placées l'une à côté de l'autre et s'engagent l'une dans l'autre par leurs dents se trouvant sur leur circonférence (figure 1.9).

Figure 1.9 Principe de fonctionnement d'une pompe à engrenage.

Les pompes à engrenage externe comportent:

- une roue **dentée menée**;
- La **roue dentée menante** reçoit son mouvement d'un moteur.

Ces roues tournent en sens opposé en s'engrenant l'une dans l'autre.

En face de l'orifice d'admission, les deux roues dentées se séparent en créant un vide partiel comblé par l'huile provenant du réservoir.

L'huile est ensuite transportée par les alvéoles formées par le creux des dents et le corps de la pompe.

Des plaquettes assurent l'étanchéité axiale des alvéoles, c'est-à-dire qu'elles empêchent l'huile de fuir par les côtés des alvéoles.

Au fur et à mesure que les dents se réengagent, l'huile est évacuée vers l'orifice de refoulement.

La figure 1.9 donne le principe de fonctionnement d'une pompe à engrenage. (appuyer sur Marche)

Sous l'effet de la pression existant du côté du refoulement de la pompe, les deux roues dentées sont poussées contre le corps de la pompe à cause de l'espace existant entre la face des dents des roues dentées et le corps de la pompe.

L'engrènement précis des dents assure l'étanchéité entre l'aspiration et le refoulement et réduit les fuites internes à un niveau minimum.

- L'espace disponible tend à **s'amplifier** à mesure que **la pompe prend de l'âge** et s'use.
- **Les pertes volumétriques augmentent** donc en fonction de l'usure de la pompe.
- Il en résulte **un faible rendement volumétrique.**

Pompes à engrenage externe:construction

La figure 1.10 vous montre une vue éclatée d'une pompe à

engrenage externe. Vous pouvez y remarquer la plaquette d'étanchéité qui assure l'étanchéité axiale de la pompe.

Figure 1.10 Vue éclatée d'une pompe à engrenage externe.

cliquez sur les éléments pour avoir leur définition.

Parker

La figure 1.11 présente une vue en coupe d'une pompe à engrenage externe.

Figure 1.11 Vue en coupe d'une pompe à engrenage externe.



Il existe également des pompes à engrenage externe double.

Une pompe à engrenage double est en fait l'union de deux pompes à engrenage, lesquelles sont entraînées par le même arbre d'accouplement.

La figure 1.12 vous montre une vue en coupe d'une pompe à engrenage externe double.

Figure 1.12 Pompe à engrenage externe double.



Bosch

Les pompes à engrenage externe double ont les mêmes caractéristiques de fonctionnement qu'une pompe à engrenage externe simple:

- Elles possèdent un seul orifice d'admission commun aux deux pompes.
- Chacune des pompes fournit son propre débit par son propre orifice de refoulement.

Une pompe à engrenage externe double **peut alimenter deux circuits hydrauliques indépendants** ou fournir **un plus grand débit** à un seul circuit.

Le montage d'une pompe triple est également possible.

Vous pouvez voir à la figure 1.13 les symboles utilisés pour représenter les pompes simples, doubles et triples.

Notez que ces symboles concernent tous les types de pompes.

Figure 1.13 Symboles standards des pompes.

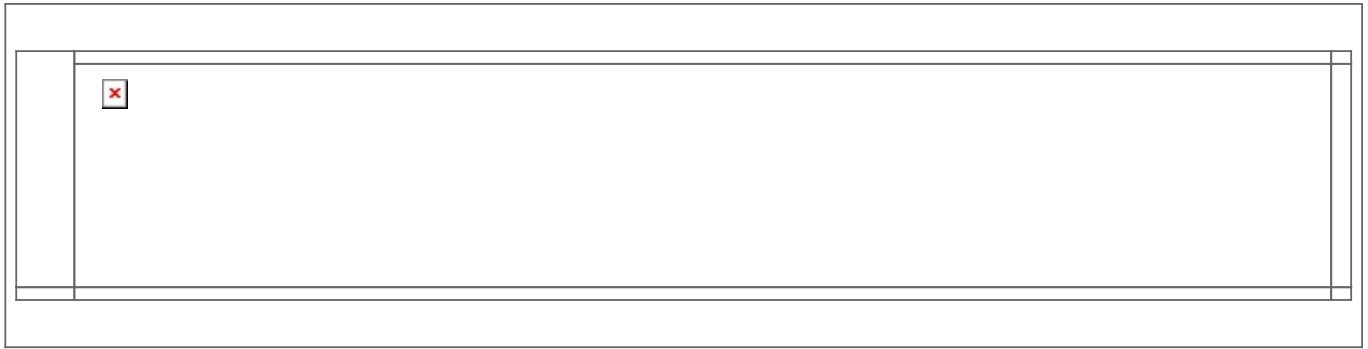

Axcom

Pompes à engrenage interne

Les pompes à engrenage interne tirent leur nom du fait qu'elles possèdent comme pièce mobile une roue à denture interne (figure 1.14).

Figure 1.14 Roue à denture interne.

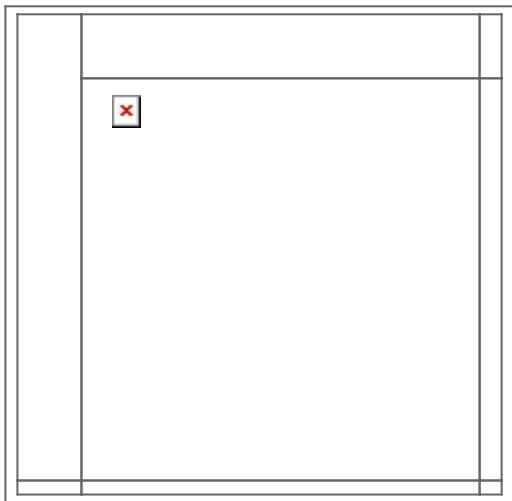

Il existe deux principaux types de pompes à engrenage interne :

1. les pompes à engrenage interne à **croissant** ;
2. **les pompes à engrenage interne à gérotor.**

Pompes à engrenage interne à croissant

La pompe à engrenage interne à croissant comprend deux roues à denture:

- une roue à denture **interne**

- une roue à denture **externe**,

Ces roues sont séparées par un croissant fixe.

- La roue à denture externe entraîne la roue à denture interne.
- la roue à denture externe est excentrique par rapport à la roue à denture interne;
- les deux roues dentées tournent dans le même sens.

La figure 1.15 représente le principe de fonctionnement d'une pompe à engrenage interne à croissant.

Figure 1.15 Principe de fonctionnement d'une pompe à engrenage interne à croissant.

Vickers

Il existe des pompes double ou triple à engrenage interne à croissant.

Pompes à engrenage interne à gérotor

Le fonctionnement des pompes à engrenage interne à gérotor ressemble beaucoup à celui des pompes à engrenage interne à croissant.

La figure 1.16 vous présente le cycle de fonctionnement.

Figure 1.16 Cycle de fonctionnement d'une pompe à engrenage interne à gérotor.



Sur cette figure:

- le lobe en pointillé de gauche représente l'orifice de refoulement,
- tandis que celui de droite représente l'orifice d'admission (partie A de la figure 1.16).

Fonctionnement:

1. La rotation des deux roues dentées se fait dans le sens des aiguilles d'une montre (sens horaire).
2. Le fluide hydraulique est aspiré par la cavité créée lors du désengagement des deux roues dentées.
3. Le désengagement s'effectue vis-à-vis de l'orifice d'admission (parties B et C de la figure 1.16).
4. Le fluide devient prisonnier dans l'alvéole créée entre les roues à denture externe et interne (partie D de la figure 1.16).
5. Lors du réengagement des deux roues à denture (parties E, F et G de la figure 1.16), le fluide est refoulé vers l'orifice de refoulement.
6. Le cycle, ainsi complété, recommence.

La figure 1.17 vous présente une vue en coupe d'une pompe à engrenage interne à gérotor.

Figure 1.17 Vue en coupe d'une pompe à engrenage interne à gérotor.

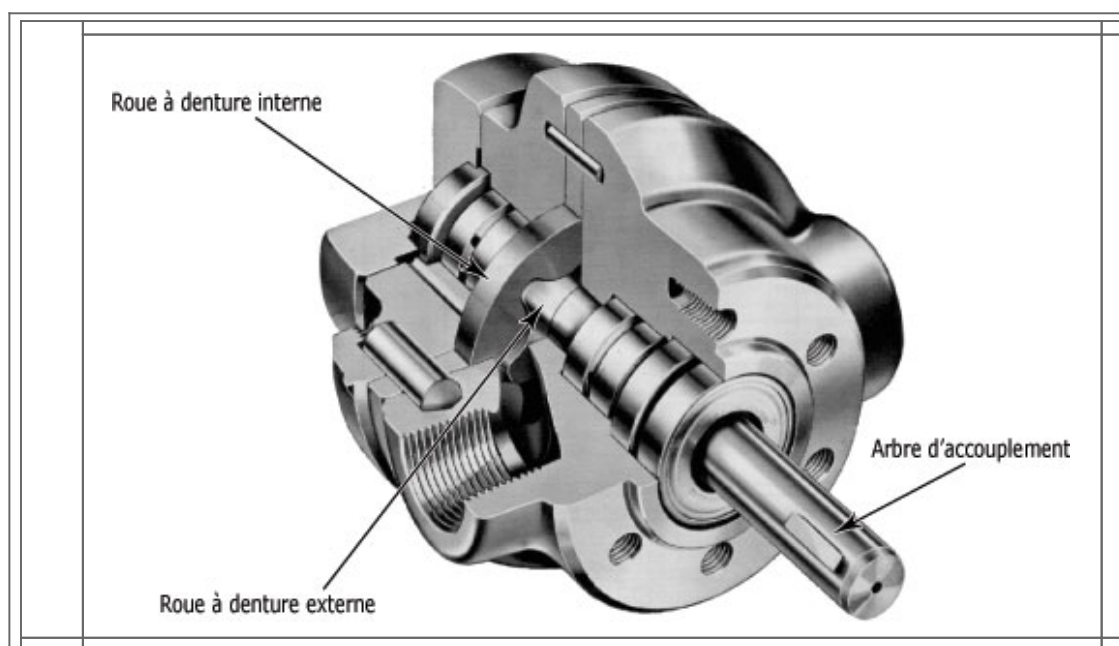

Il existe également des pompes doubles à engrenage interne à gérotor.

Certaines de ces pompes possèdent deux orifices d'admission indépendants et deux orifices de refoulement indépendants. figure 1.18

Figure 1.18 Pompe double à engrenage interne à gérotor (orifices indépendants).

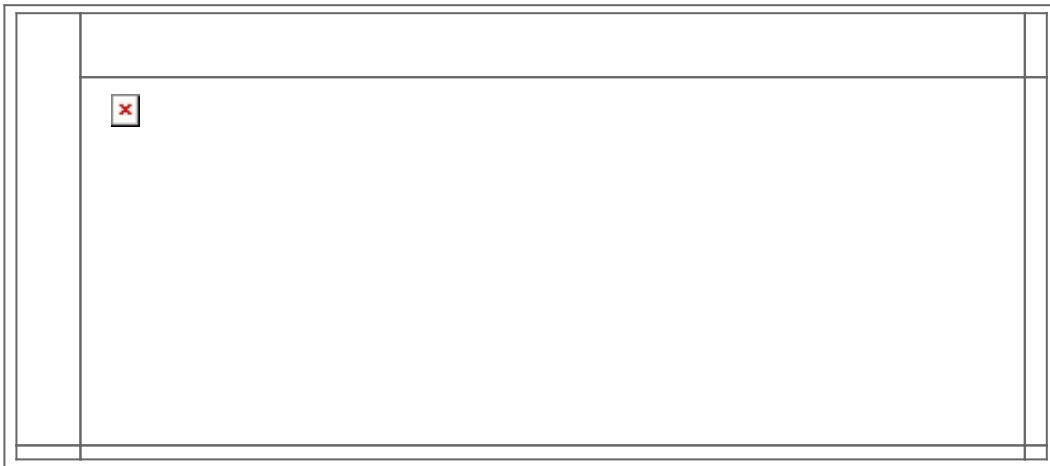

D'autres pompes du même type possèdent un seul orifice d'admission et un seul orifice de refoulement. figure 1.19.

Figure 1.19 Pompe double à engrenage interne à gérotor (orifices communs).

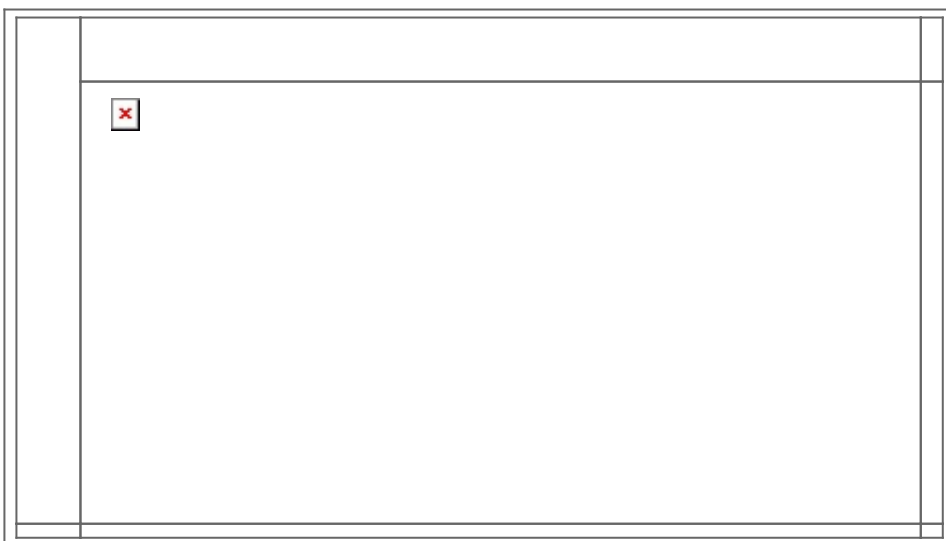

Dans le cas des pompes doubles à un seul orifice d'admission et un seul orifice de refoulement, **l'admission et le refoulement se divisent en deux à l'intérieur du carter de la pompe.**

Pompes à palettes

Les pompes hydrauliques volumétriques à palettes sont fréquemment utilisées parce qu'elles ont un bon rendement volumétrique :

- Elles offrent généralement **un meilleur rendement volumétrique** que les pompes à engrenage.
- Elles sont toutefois plus **coûteuses** que ces dernières.

Les pompes à palettes renferment des palettes:

- Celles-ci sont de forme rectangulaire;
- et sont introduites à l'intérieur du rotor par l'entremise de rainures radiales (figure 1.23). Les palettes peuvent donc se déplacer radialement.

Figure 1.23 Rotor d'une pompe hydraulique volumétrique à palettes.

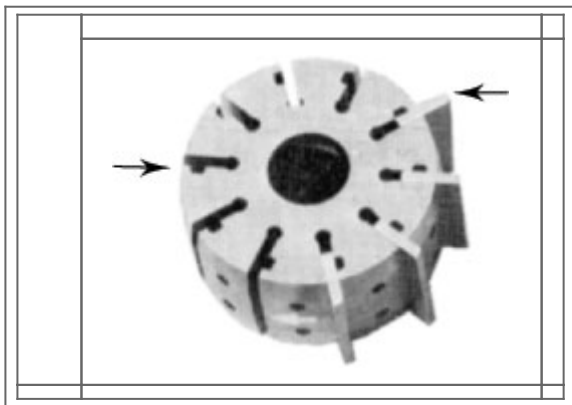

Vickers

Il existe deux catégories de pompes à palettes :

1. les pompes à palettes à cylindrée fixe;
2. les pompes à palettes à cylindrée variable.

Pompes à palettes à cylindrée fixe

Les pompes à palettes à cylindrée fixe se divisent en deux

groupes :

1. les pompes à palettes à cylindrée fixe à rotor non balancé;
2. les pompes à palettes à cylindrée fixe à rotor balancé.

Pompes à palettes à cylindrée fixe à rotor non balancé

Les pompes à palettes à cylindrée fixe à rotor non balancé La figure 1.24 ont un principe de fonctionnement relativement simple:

- Le rotor dans lequel sont introduites les palettes, est installé dans le carter de la pompe.
- Il est excentrique par rapport au centre du corps de la pompe.

Figure 1.24 Principe de fonctionnement d'une pompe à palettes à cylindrée fixe à rotor non balancé.

Fonctionnement:

Le rotor est entraîné dans un mouvement de rotation grâce à l'arbre d'accouplement relié à la source motrice de la pompe.

La force centrifuge, ainsi créée, pousse les palettes contre une couronne circulaire. Lorsque le rotor tourne, les palettes suivent le contour de la couronne. Il est à noter que le **chanfrein** de la palette suit toujours le sens de rotation. Il en est ainsi pour tous les types de pompes à palettes.

A cause **de l'excentricité du rotor** par rapport à la couronne, **les palettes divisent l'espace compris entre le rotor et la couronne en une série d'alvéoles**. L'aspiration de la pompe se fait à l'endroit où les alvéoles augmentent de volume. **Il se crée ainsi un vide partiel** qui

www.mbsm.pro , Porte-fusible à couteaux HPC ultra rapide

written by mahdi miled | 12 August 2018

Généralités

Généralités

Les cartouches-fusible HPC des classes de fonctionnement gG et gL protègent les appareils électriques des sur charges et des courts-circuits. Elles sont destinées avant tout à la protection des circuits électriques basse tension. Ces classes de fonctionnement gG et gL impliquent la coupure en toute sécurité de tout courant capable de faire fondre le fusible.

mbsmdotpro- porte-fusible-couteaux-ultra-rapide.jpg (83 KB)



Picture5 Mbsm Dot Pro : www.mbsm.pro

mbsmdotpro- porte-fusible-couteaux-ultra-rapide.jpg (91 KB)



www.mbsm.pro , Practical Electronics for Inventors, Fourth Edition

written by mahdi miled | 12 August 2018

Practical Electronics for Inventors, Fourth Edition

by: Paul Scherz, Dr. Simon Monk

Abstract: A fully updated, no-nonsense guide to electronics. Advance your electronics knowledge and gain the skills necessary to develop and construct your own functioning gadgets. Written by a pair of experienced engineers and dedicated hobbyists, Practical Electronics for Inventors, Fourth Edition, lays out the essentials and provides step-by-step instructions, schematics, and illustrations. Discover how to select the right components, design and build circuits, use microcontrollers and ICs, work with the latest software tools, and test and tweak your creations. This easy-to-follow book features new instruction on programmable logic, semiconductors, operational amplifiers, voltage regulators, power supplies, digital electronics, and more. Coverage includes:

- Resistors, capacitors, inductors, and transformers
- Diodes, transistors, and integrated circuits
- Optoelectronics, solar cells, and phototransistors
- Sensors, GPS modules, and touch screens
- Op amps, regulators, and power supplies
- Digital electronics, LCDs, and logic gates
- Microcontrollers and prototyping platforms
- Combinational and sequential programmable logic
- DC motors, RC servos, and stepper motors
- Microphones, audio amps, and speakers
- Modular electronics and prototypes

Book Details

Title: Practical Electronics for Inventors, Fourth Edition

Publisher: McGraw-Hill Education: New York, Chicago, San Francisco, Athens, London, Madrid, Mexico City, Milan, New Delhi, Singapore, Sydney, Toronto

Copyright / Pub. Date: 2016 McGraw-Hill Education

ISBN: 9781259587542

Authors:

Paul Scherz is a Systems Operation Manager who received his B.S. in physics from the University of Wisconsin. He is an inventor/hobbyist in electronics, an area he grew to appreciate through his experience at the University's Department of Nuclear Engineering and Engineering Physics and Department of Plasma Physics.

Dr. Simon Monk has a bachelor's degree in cybernetics and computer science and a Ph.D. in software engineering. He spent several years as an academic before he returned to industry, co-founding the mobile software company Momote Ltd. He has been an active electronics hobbyist since his early teens and is a full-time writer on hobby electronics and open-source hardware. Dr. Monk is author of numerous electronics books, including Programming Arduino, Hacking Electronics, and Programming the Raspberry Pi.

Description: A fully updated, no-nonsense guide to electronics. Advance your electronics knowledge and gain the skills necessary to develop and construct your own functioning gadgets. Written by a pair of experienced engineers and dedicated hobbyists, Practical Electronics for Inventors, Fourth Edition, lays out the essentials and provides step-by-step instructions, schematics, and illustrations. Discover how

to select the right components, design and build circuits, use microcontrollers and ICs, work with the latest software tools, and test and tweak your creations. This easy-to-follow book features new instruction on programmable logic, semiconductors, operational amplifiers, voltage regulators, power supplies, digital electronics, and more. Coverage includes:

- Resistors, capacitors, inductors, and transformers
- Diodes, transistors, and integrated circuits
- Optoelectronics, solar cells, and phototransistors
- Sensors, GPS modules, and touch screens
- Op amps, regulators, and power supplies
- Digital electronics, LCDs, and logic gates
- Microcontrollers and prototyping platforms
- Combinational and sequential programmable logic
- DC motors, RC servos, and stepper motors
- Microphones, audio amps, and speakers
- Modular electronics and prototypes

Table of Contents

A. ABOUT THE AUTHORS

B. PREFACE

C. ACKNOWLEDGMENTS

1. Introduction to Electronics
2. Theory
3. Basic Electronic Circuit Components
4. Semiconductors
5. Optoelectronics
6. Sensors
7. Hands-on Electronics
8. Operational Amplifiers
9. Filters
10. Oscillators and Timers
11. Voltage Regulators and Power Supplies
12. Digital Electronics
13. Microcontrollers
14. Programmable Logic
15. Motors
16. Audio Electronics

17. Modular Electronics

A. Power Distribution and Home Wiring

B. Error Analysis

C. Useful Facts and Formulas

Tools & Media

figure (1 036)

table (64)

Expanded Table of Contents

A. ABOUT THE AUTHORS

PREFACE PRELIMINARIES

ABOUT THE TECHNICAL EDITORS

B. PREFACE

PREFACE PRELIMINARIES

Notes about the Fourth Edition

C. ACKNOWLEDGMENTS

1. Introduction to Electronics

CHAPTER PRELIMINARIES

2. Theory

CHAPTER PRELIMINARIES

Theory of Electronics

Electric Current

Voltage

A Microscopic View of Conduction (for Those Who Are Interested)

Resistance, Resistivity, Conductivity

Insulators, Conductors, and Semiconductors

Heat and Power

Thermal Heat Conduction and Thermal Resistance

Wire Gauges

Grounds

Electric Circuits

Ohm's Law and Resistors

Voltage and Current Sources

Measuring Voltage, Current, and Resistance

Combining Batteries
Open and Short Circuits
Kirchhoff's Laws
Superposition Theorem
Thevenin's and Norton's Theorems
AC Circuits
AC and Resistors, RMS Voltage, and Current
Mains Power
Capacitors
Inductors
Modeling Complex Circuits
Complex Numbers
Circuit with Sinusoidal Sources
Power in AC Circuits (Apparent Power, Real Power, Reactive Power)
Thevenin's Theorem in AC Form
Resonant Circuits
Lecture on Decibels
Input and Output Impedance
Two-Port Networks and Filters
Transient Circuits
Circuits with Periodic Nonsinusoidal Sources
Nonperiodic Sources
SPICE

3. Basic Electronic Circuit Components

CHAPTER PRELIMINARIES

Wires, Cables, and Connectors
Batteries
Switches
Relays
Resistors
Capacitors
Inductors
Transformers
Fuses and Circuit Breakers

4. Semiconductors

CHAPTER PRELIMINARIES

Semiconductor Technology

Diodes

Transistors

Thyristors

Transient Voltage Suppressors

Integrated Circuits

5. Optoelectronics

CHAPTER PRELIMINARIES

A Little Lecture on Photons

Lamps

Light-Emitting Diodes

Photoresistors

Photodiodes

Solar Cells

Phototransistors

Photothyristors

Optoisolators

Optical Fiber

6. Sensors

CHAPTER PRELIMINARIES

General Principles

Temperature

Proximity and Touch

Movement, Force, and Pressure

Chemical

Light, Radiation, Magnetism, and Sound

GPS

7. Hands-on Electronics

CHAPTER PRELIMINARIES

Safety

Constructing Circuits

Multimeters

Oscilloscopes

The Electronics Laboratory

8. Operational Amplifiers

CHAPTER PRELIMINARIES

Operational Amplifier Water Analogy

How Op Amps Work (The “Cop-Out” Explanation)

Theory

Negative Feedback

Positive Feedback

Real Kinds of Op Amps

Op Amp Specifications

Powering Op Amps

Some Practical Notes

Voltage and Current Offset Compensation

Frequency Compensation

Comparators

Comparators with Hysteresis

Using Single-Supply Comparators

Window Comparator

Voltage-Level Indicator

Instrumentation Amplifiers

Applications

9. Filters

CHAPTER PRELIMINARIES

Things to Know Before You Start Designing Filters

Basic Filters

Passive Low-Pass Filter Design

A Note on Filter Types

Passive High-Pass Filter Design

Passive Bandpass Filter Design

Passive Notch Filter Design

Active Filter Design

Integrated Filter Circuits

10. Oscillators and Timers

CHAPTER PRELIMINARIES

RC Relaxation Oscillators

The 555 Timer IC

Voltage-Controlled Oscillators

Wien-Bridge and Twin-T Oscillators

LC Oscillators (Sinusoidal Oscillators)

Crystal Oscillators

Microcontroller Oscillators

11. Voltage Regulators and Power Supplies

CHAPTER PRELIMINARIES

Voltage-Regulator ICs

A Quick Look at a Few Regulator Applications

The Transformer

Rectifier Packages

A Few Simple Power Supplies

Technical Points about Ripple Reduction

Loose Ends

Switching Regulator Supplies (Switchers)

Switch-Mode Power Supplies (SMPS)

Kinds of Commercial Power Supply Packages

Power Supply Construction

12. Digital Electronics

CHAPTER PRELIMINARIES

The Basics of Digital Electronics

Logic Gates

Combinational Devices

Logic Families

Powering and Testing Logic ICs

Sequential Logic

Counter ICs

Shift Registers

Analog/Digital Interfacing

Displays

Memory Devices

13. Microcontrollers

CHAPTER PRELIMINARIES

Basic Structure of a Microcontroller

Example Microcontrollers

Evaluation/Development Boards

Arduino

Interfacing with Microcontrollers

14. Programmable Logic

CHAPTER PRELIMINARIES

Programmable Logic

FPGAs

ISE and the Elbert V2

The Elbert 2 Board

Downloads

Drawing Your FPGA Logic Design

Verilog

Describing Your FPGA Design in Verilog

Modular Design

Simulation

VHDL

15. Motors

CHAPTER PRELIMINARIES

DC Continuous Motors

Speed Control of DC Motors

Directional Control of DC Motors

RC Servos

Stepper Motors

Kinds of Stepper Motors

Driving Stepper Motors

Controlling the Driver with a Translator

A Final Word on Identifying Stepper Motors

16. Audio Electronics

CHAPTER PRELIMINARIES

A Little Lecture on Sound

Microphones

Microphone Specifications

Audio Amplifiers

Preamplifiers

Mixer Circuits

A Note on Impedance Matching

Speakers

Crossover Networks

Simple ICs Used to Drive Speakers

Audible-Signal Devices

Miscellaneous Audio Circuits

17. Modular Electronics

CHAPTER PRELIMINARIES

There's an IC for It

Breakout Boards and Modules

Plug-and-Play Prototyping

Open Source Hardware

A. Power Distribution and Home Wiring

APPENDIX PRELIMINARIES

Power Distribution

A Closer Look at Three-Phase Electricity

Home Wiring

Electricity in Other Countries

B. Error Analysis

APPENDIX PRELIMINARIES

Absolute Error, Relative Error, and Percent Error

Uncertainty Estimates

C. Useful Facts and Formulas

APPENDIX PRELIMINARIES

Greek Alphabet

Powers of 10 Unit Prefixes

Linear Functions ($y = mx + b$)

Quadratic Equation ($y = ax^2 + bx + c$)

Exponents and Logarithms

Trigonometry

Complex Numbers

Differential Calculus

Integral Calculus

1

1. <https://www.amazon.com/Practical-Electronics-Inventors-Fourth-Scherz/dp/1259587541> [back]

www-mbsm-pro-Practical-Electronics-for-Inventors-Fourth-Edition1.png (273 KB)

FOURTH EDITION

PRACTICAL ELECTRONICS FOR INVENTORS



PictureS Mbsm Dot Pro : www.mbsm.pro

[www-mbsm-pro-Practical-Electronics-for-Inventors-Fourth-Edition1.png](#) (239 KB)



www-mbsm-pro-Practical-Electronics-for-Inventors-Fourth-Edition2.png (121 KB)

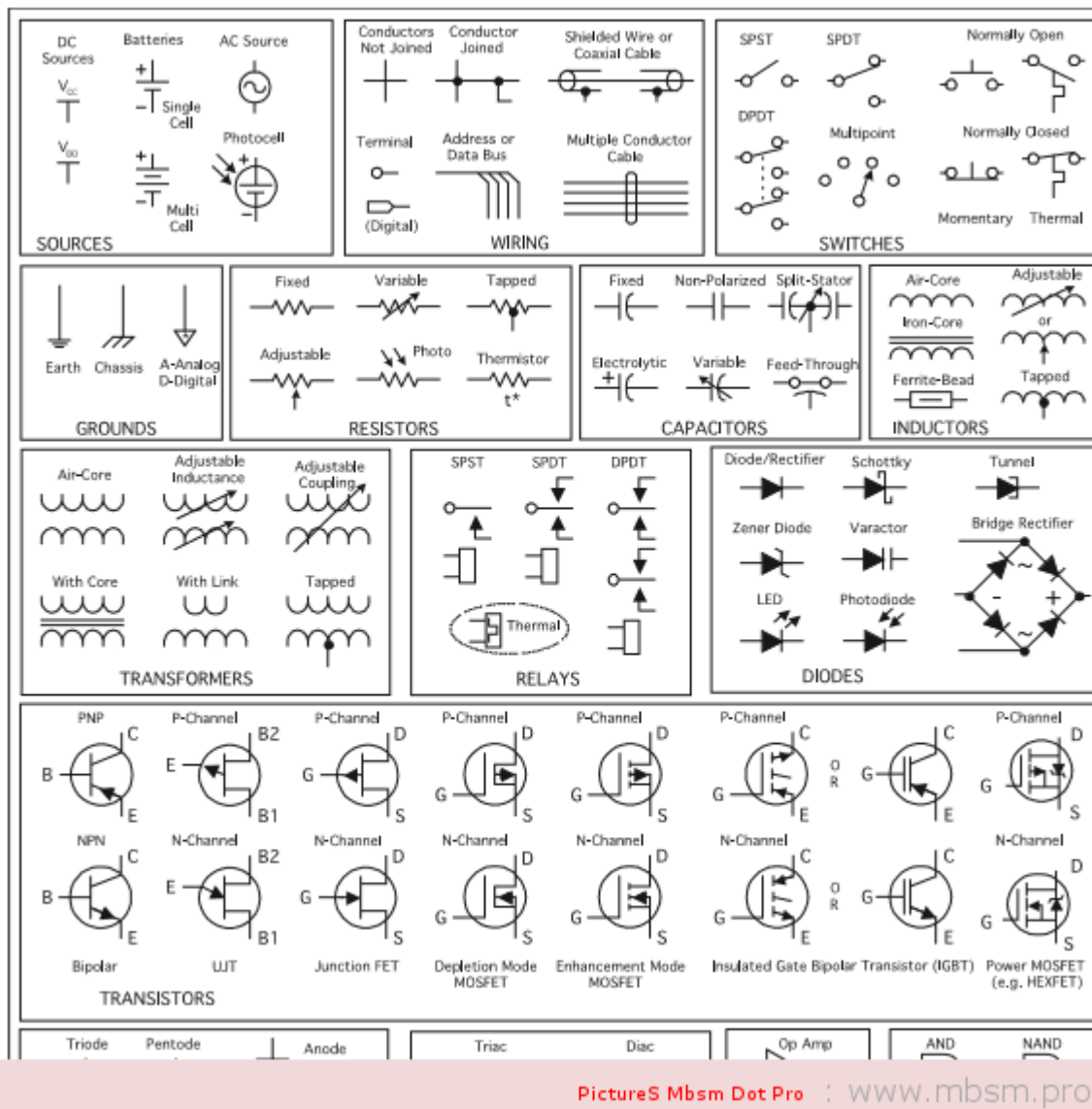

www-mbsm-pro-Practical-Electronics-for-Inventors-Fourth-Edition2.png (111 KB)





www-mbsm-pro-Practical-Electronics-for-Inventors-Fourth-Edition3.png (146 KB)

Resistor Labels

Conversion Calculator

k = 1,000 ; M = 1,000,000

1MΩ = 1,000,000 Ω = 1 x 10⁶Ω

1kΩ = 1,000 Ω = 1 x 10³Ω

Examples:

3.3 kΩ = 3,300 Ω = 3.3 x 10³Ω

22 kΩ = 22,000 Ω = 22 x 10³Ω

2 MΩ = 2,000,000 Ω = 2 x 10⁶Ω

1.68 MΩ = 1,680,000 Ω = 1.68 x 10⁶Ω

Resistor Color Code

Color	Sig. Fig.	Decimal Multiplier	Tolerance (%)
Black	0	1	-
Brown	1	10	1
Red	2	100	2
Orange	3	1,000	-
Yellow	4	10,000	-
Green	5	100,000	0.5
Blue	6	1,000,000	0.25
Purple	7	10,000,000	0.1
Gray	8	100,000,000	-
White	9	1,000,000,000	-
Gold	-	0.1	5
Silver	-	0.01	10
No Color	-	-	20

Body Color

The body color of a resistor typically doesn't carry meaning, except in some instances where it may specify temperature coefficient. However, if you find resistors within a circuit that are white/gray or blue in color, they may be non-flammable or fusible resistors. Care must be taken when entering such resistors.

4-Band Resistor Code (Most Common)

Label Meaning

Red Black Orange Gold
20 x 1,000 = 20k Ω ± 5%

First Digit Second Digit Multiplier (#of zeros) % Tolerance

5-Band Resistor Code (3-digit)

Label Meaning

Purple Blue Green Brown Brown
675 x 10 = 6750 Ω ± 1%

First Digit Second Digit Third Digit Multiplier (#of zeros) % Tolerance

5-Band Resistor Code (Reliability)

Label Meaning

Yellow Purple Green Silver Brown
47 x 100,000 = 4.7 MΩ ± 10%

1% Reliability/1000 Hr — Brown

Color	Reliability (%/1000 Hr)
Brown	1
Red	0.1
Orange	0.01
Yellow	0.001

First Digit Second Digit Multiplier (#of zeros) Reliability % Tolerance

6-Band Resistor Code

Label Meaning

Purple Red Black Blue Brown Red
276 x 1 = 276Ω ± 1%

TC of 50 ppm — Red

Color	Temp. Coeff
Brown	100 ppm
Red	50 ppm

First Digit Second Digit Third Digit Multiplier (#of zeros) Temp. Coeff. % Tolerance

Surface Mount Resistor Code

3-digit Label

Label Meaning

101 10 and 1 zero = 100 Ω

105 10 and 5 zero = 1,000,000 Ω

224 22 and 4 zeros = 220,000 Ω

1R0 1.0 and no zeros = 1 Ω

22R 22.0 and no zeros = 22 Ω

R10 0.1 and no zeros = 0.1 Ω

The first two digits represent significant figures; the last digit specifies the multiplier. For values under 100 Ω, the letter R is substituted for one of the significant digits and represents a decimal point.

4-digit Label

Label Meaning

1001 100 and 1 zero = 1000 Ω

22R0 22.0 and no zeros = 22 Ω

The first three digits represent significant figures; the last digit specifies the multiplier. R represents a decimal point.

Tolerance Label

Label Meaning

101F 100 Ω ± 1%

Letter	Tolerance
D	±0.5 %
F	±1.0 %
G	±2.0 %
J	±5.0 %
K	±10.0 %
M	±20.0 %
P	±1.0 %
R	±0.5 %
S	±0.25 %
T	±0.1 %
Z	±20.0 %

PictureS Mbsm Dot Pro : www.mbsm.pro

www-mbsm-pro-Practical-Electronics-for-Inventors-Fourth-Edition3.png (134 KB)

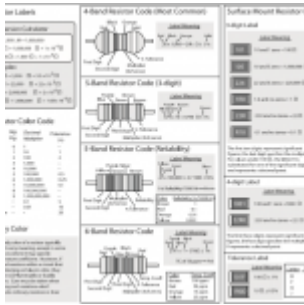
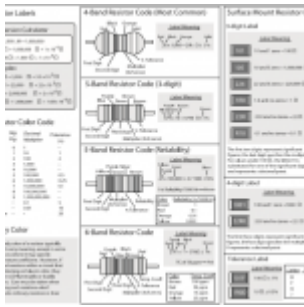

www-mbsm-pro-Practical-Electronics-for-Inventors-Fourth-Edition4.png (193 KB)

Capacitor Markings

Capacitance Conversion Calculator

$1 \text{ F} = 1 \times 10^6 \mu\text{F} = 1 \times 10^9 \text{ nF} = 1 \times 10^{12} \text{ pF}$
 $1 \mu\text{F} = 1 \times 10^{-6} \text{ F} = 1 \times 10^3 \text{ nF} = 1 \times 10^6 \text{ pF}$
 $1 \text{ nF} = 1 \times 10^{-9} \text{ F} = 1 \times 10^{-3} \mu\text{F} = 1 \times 10^3 \text{ pF}$
 $1 \text{ pF} = 1 \times 10^{-12} \text{ F} = 1 \times 10^{-6} \mu\text{F} = 1 \times 10^{-3} \text{ nF}$

F = Farad, μ = micro, n = nano, p = pico

$1000 \mu\text{F} = 1,000,000 \text{ nF} = 10 \times 10^8 \text{ pF}$
 $100 \mu\text{F} = 100,000 \text{ nF} = 10 \times 10^7 \text{ pF}$
 $10 \mu\text{F} = 10,000 \text{ nF} = 10 \times 10^6 \text{ pF}$
 $1 \mu\text{F} = 1,000 \text{ nF} = 10 \times 10^5 \text{ pF}$
 $0.1 \mu\text{F} = 100 \text{ nF} = 10 \times 10^4 \text{ pF}$
 $0.01 \mu\text{F} = 10 \text{ nF} = 10 \times 10^3 \text{ pF}$
 $0.001 \mu\text{F} = 1 \text{ nF} = 10 \times 10^2 \text{ pF}$

Tantalum

Label meaning 1

1st significant figure in μF
2nd significant figure in μF
Multiplier (See table)
Voltage

Color	S.F.	Multiple	Voltage
Black	0	1	10V
Brown	1	10	
Red	2	100	
Orange	3	1000	
Yellow	4		6.3V
Green	5		16V
Blue	6		20V
Violet	7		
Gray	8	0.01	25V
White	9	0.1	3V
Pink			35V

Label meaning 2

Marking	Actual
22	22 μF , 16 V

Mylar (Polyester Film)
Polypropylene
Dipped Mica

Label meaning

Marking	Actual
.001K*	0.001 μF , $\pm 10\%$
104K	0.1 μF , $\pm 10\%$
22J*	0.22 μF , $\pm 5\%$
472K	0.0047 μF , $\pm 10\%$
221J	220 pF, $\pm 5\%$
470J	47 pF, $\pm 5\%$
102J	1000 pF, $\pm 5\%$
103F	0.01 μF , $\pm 1\%$
223F	0.022 μF , $\pm 1\%$

Ceramic Disc Capacitors

Temperature Coefficient Color Code

121K: 120 pF $\pm 10\%$
4R7D: 4.7 pF $\pm 0.5\text{pF}$

Multiplier Code

Numeric Character	Decimal Multiplier (pF)
0	None
1	10
2	100
3	1000
4	10,000

EIA Capacitor Tolerance Codes

Letter	$\leq 10 \text{ pF}$	$\geq 10 \text{ pF}$
B	$\pm 0.1 \text{ pF}$	-
C	$\pm 0.25 \text{ pF}$	-
D	$\pm 0.5 \text{ pF}$	-
E	-	$\pm 25\%$
F	-	$\pm 1\%$
G	-	$\pm 2\%$
H	-	$\pm 2.5\%$
J	-	$\pm 5\%$
K	-	$\pm 10\%$
M	-	$\pm 20\%$
P	-	-0 + 100%
S	-	-20 + 50%
W	-	-0 + 200%
X	-	-20 + 40%
Z	-	-20 + 80%

EIA Temperature Characteristic Codes

Minimum temperature	Maximum temperature	Max cap. change over temp. range
X -55°C	2 +45°C	A $\pm 1.0\%$
Y -35°C	4 +65°C	B $\pm 1.5\%$
Z +10°C	5 +85°C	C $\pm 2.2\%$
	6 +105°C	D $\pm 3.3\%$
	7 +125°C	E $\pm 4.7\%$
		F $\pm 7.5\%$
		P $\pm 10\%$
		R $\pm 15\%$
		S $\pm 22\%$
		T -33% + 22%
		U -56% + 22%
		V -82% + 22%

Ceramic Disc (European Markings)

Label Meaning

Marking	Actual	Marking	Actual
p68	0.68 pF	22p	22 pF
1p0	1.0 pF	n10	0.1 nF
4p7	4.7 pF	n27	0.27 nF

Fixed Ceramic Color Code

Color	S.F.	Tolerance	Temp. Coeff. ppm/°C
Black	0	$\pm 20\%$	2.0 pF
Brown	1	$\pm 1\%$	-30
Red	2	$\pm 2\%$	-40
Orange	3	$\pm 3\%$	-50
Yellow	4	$\pm 4\%$	-60
Green	5	$\pm 5\%$	-70
Blue	6	$\pm 6\%$	-80
Violet	7	$\pm 7\%$	-90
Gray	8	$\pm 8\%$	-100
White	9	$\pm 9\%$	-110

Surface Mount Capacitors

PictureS Mbsm Dot Pro : www.mbsm.pro

www-mbsm-pro-Practical-Electronics-for-Inventors-for-Inventors-Fourth-Edition4.png (178 KB)

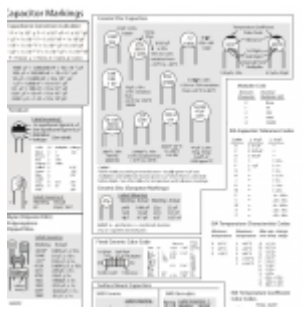

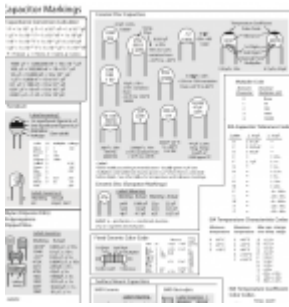

www.mbsm.pro , Finition Electricité partie 1

written by mahdi miled | 12 August 2018



www.mbsm.pro , Finition Électricité partie 1

Image : <https://www.facebook.com/www.hegay/>

mbsm-dot-pro-electricitee-X.jpg (49 KB)



PictureS Mbsm Dot Pro : www.mbsm.pro

mbsm-dot-pro-electricitee-X.jpg (57 KB)



mbsm-dot-pro-electricitee-C.jpg (22 KB)



mbsm-dot-pro-electricitee-C.jpg (28 KB)



mbsm-dot-pro-electricitee-D.jpg (29 KB)



mbsm-dot-pro-electricitee-D.jpg (37 KB)



mbsm-dot-pro-electricitee-E.jpg (28 KB)



mbsm-dot-pro-electricitee-E.jpg (34 KB)



mbsm-dot-pro-electricitee-F.jpg (42 KB)



mbsm-dot-pro-electricitee-F.jpg (49 KB)



mbsm-dot-pro-electricitee-G.jpg (42 KB)



mbsm-dot-pro-electricitee-G.jpg (49 KB)



mbsm-dot-pro-electricitee-H.jpg (31 KB)



mbsm-dot-pro-electricitee-H.jpg (37 KB)



mbsm-dot-pro-electricitee-I.jpg (28 KB)



mbsm-dot-pro-electricitee-I.jpg (33 KB)



mbsm-dot-pro-electricitee-W.jpg (55 KB)



mbsm-dot-pro-electricitee-W.jpg (63 KB)



mbsm-dot-pro-electricitee-K.jpg (34 KB)



PictureS Mbsm Dot Pro : www.mbsm.pro

mbsm-dot-pro-electricitee-K.jpg (39 KB)





mbsm-dot-pro-electricitee-M.jpg (29 KB)



mbsm-dot-pro-electricitee-M.jpg (35 KB)



mbsm-dot-pro-electricitee-N.jpg (47 KB)



mbsm-dot-pro-electricitee-N.jpg (54 KB)

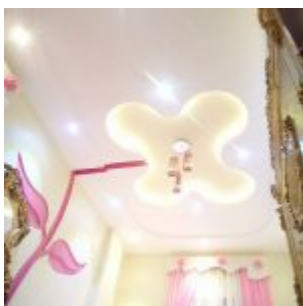



mbsm-dot-pro-electricitee-0.jpg (37 KB)



mbsm-dot-pro-electricitee-0.jpg (45 KB)



mbsm-dot-pro-electricitee-P.jpg (42 KB)

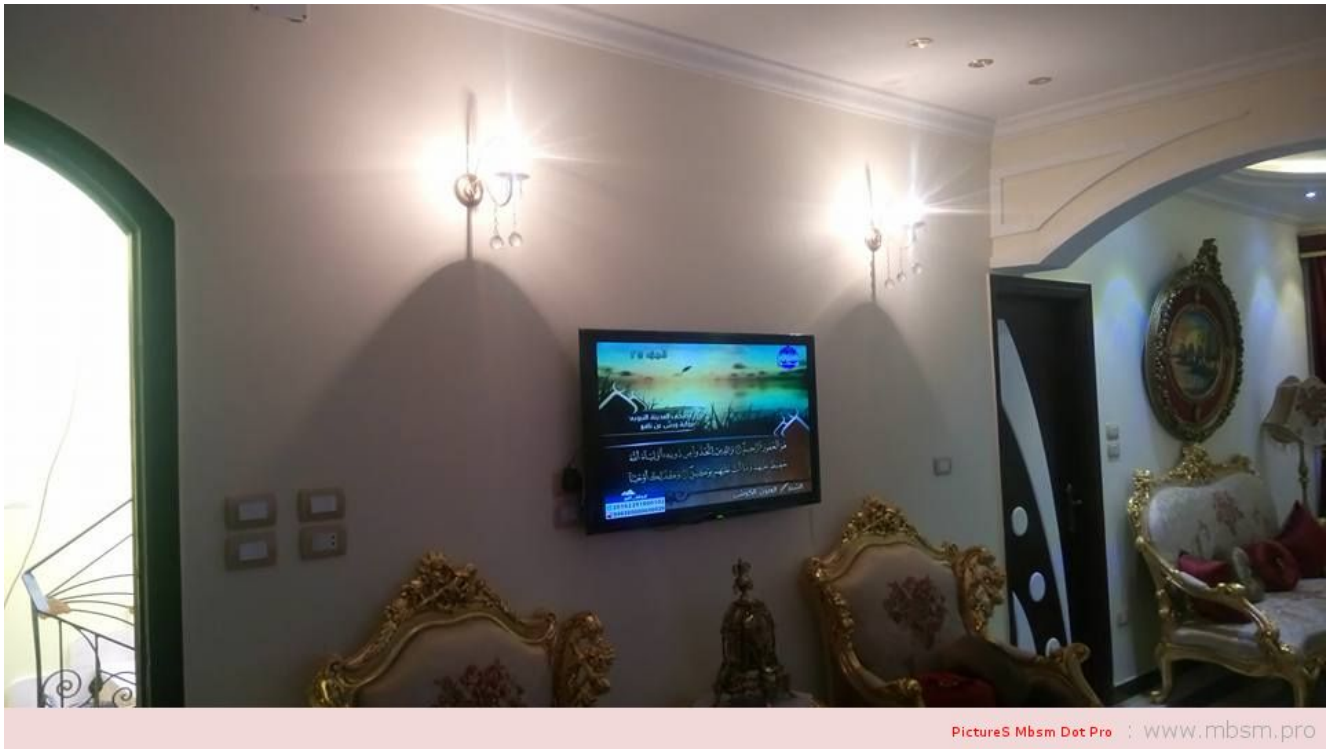

mbsm-dot-pro-electricitee-P.jpg (47 KB)

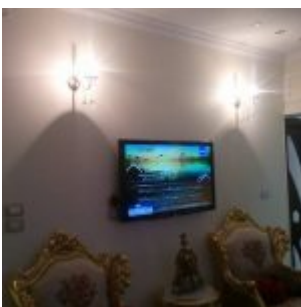
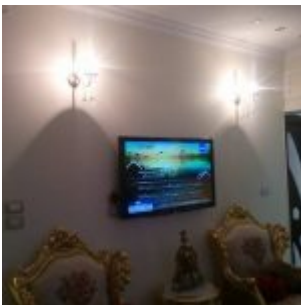

mbsm-dot-pro-electricitee-Q.jpg (58 KB)

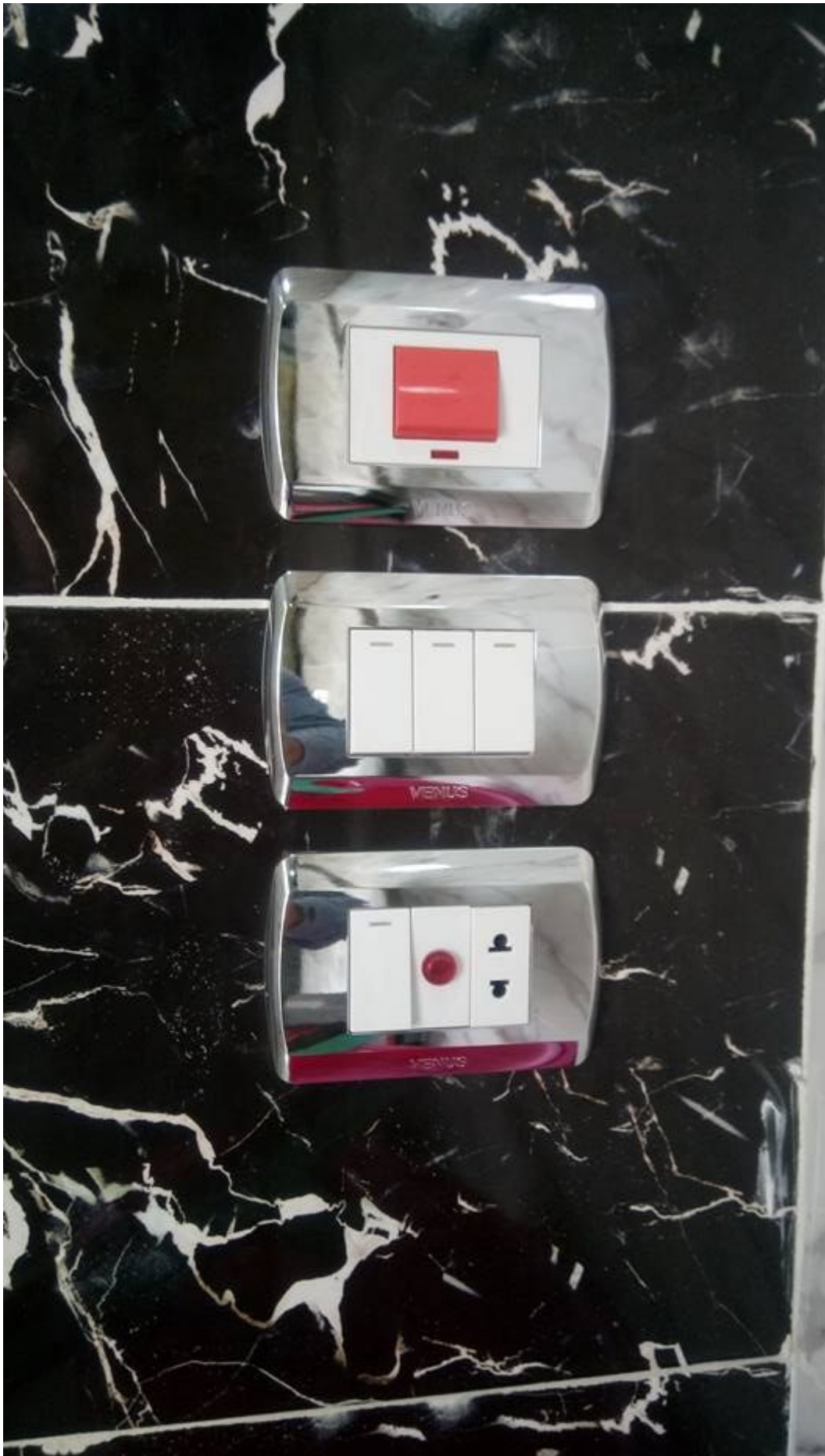

mbsm-dot-pro-electricitee-Q.jpg (69 KB)



mbsm-dot-pro-electricitee-R.jpg (50 KB)



PictureS Mbsm Dot Pro : www.mbsm.pro

mbsm-dot-pro-electricitee-R.jpg (58 KB)



mbsm-dot-pro-electricitee-S.jpg (43 KB)



mbsm-dot-pro-electricitee-S.jpg (52 KB)

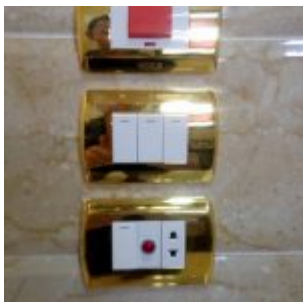

mbsm-dot-pro-electricitee-Y.jpg (71 KB)



mbsm-dot-pro-electricitee-Y.jpg (82 KB)



mbsm-dot-pro-electricitee-V.jpg (33 KB)



PictureS Mbsm Dot Pro : www.mbsm.pro

mbsm-dot-pro-electricitee-V.jpg (41 KB)



www.mbsm.pro , branchement de detecteur de mouvement infrarouge exterieur

written by mahdi miled | 12 August 2018

www.mbsm.pro , branchement de detecteur de mouvement
infrarouge exterieur

mbsm_dot_pro_detecteur2.jpg (42 KB)



Picture5 Mbsm Dot Pro : www.mbsm.pro

mbsm_dot_pro_detecteur2.jpg (49 KB)





mbsm_dot_pro_detecteur.png (26 KB)

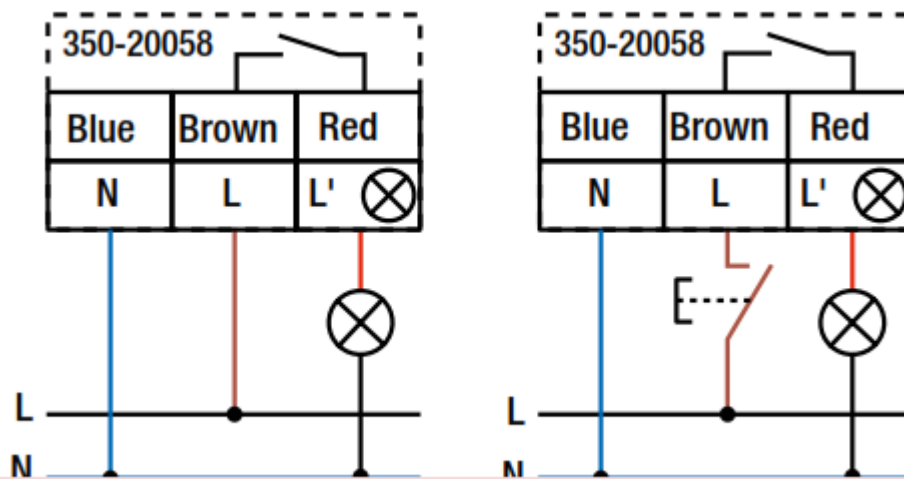

PictureS Mbsm Dot Pro : www.mbsm.pro

mbsm_dot_pro_detecteur.png (26 KB)

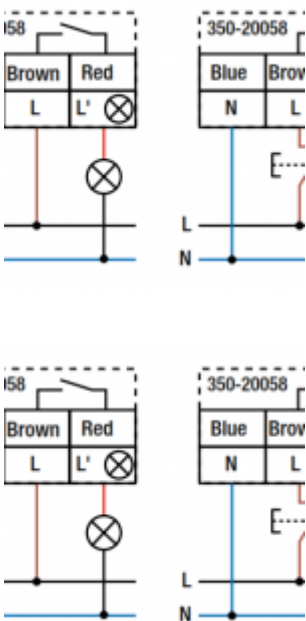

mbsm_dot_pro_detecteur1.png (167 KB)

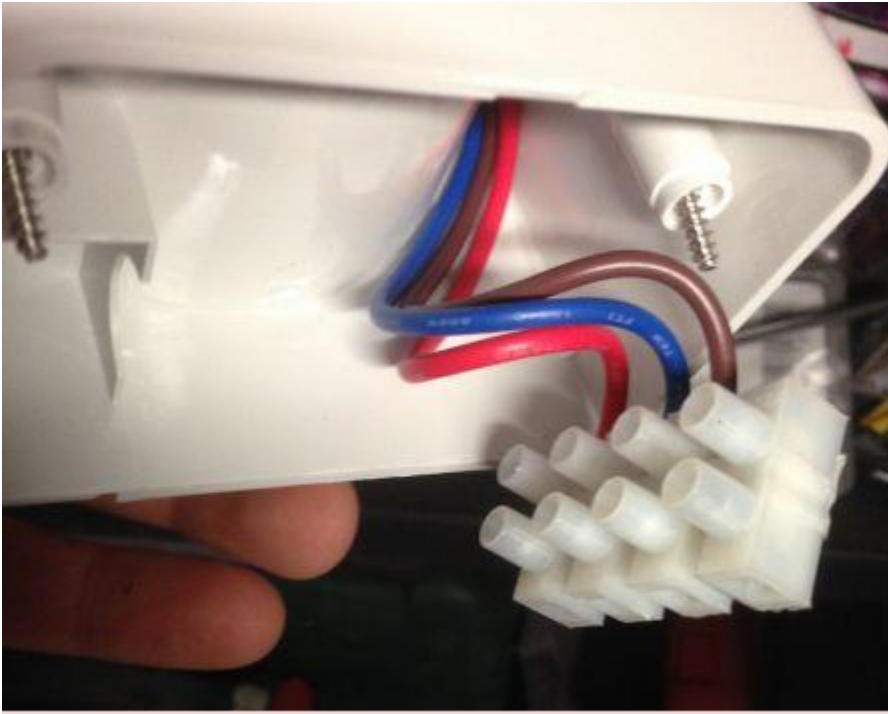

PictureS Mbsm Dot Pro : www.mbsm.pro

mbsm_dot_pro_detecteur1.png (156 KB)

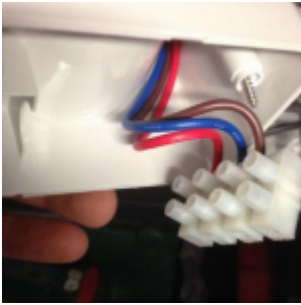

قصيدة بمناسبة اليوم العالمي للمرأة للشاعر التونسي منير بن صالح ميلاد

written by mahdi miled | 12 August 2018

International_Women's_Day_mbsm_dot_pro.jpg (203 KB)



International_Women's_Day_mbsm_dot_pro.jpg (189 KB)





International_Women's_Day_mbsm_dot_pro2.png (34 KB)

أعترف يا قلبي أنك تحب كل النساء
أعترف أنك لست من الحمقى ولا من الجبناء
ولست طاغوت دين يجالس السفهاء
أنت يا قلبي تعشق جنس الطيبة والوفاء
وتاجا من النور على رؤوس النبلاء
نساء صنعن بأيديهن التاريخ ولبيّن النداء
ورفعن راية المجد عالية في غياهب السماء
سَأَعِيشُ رَعْمَ الدَّاءِ والأَعْدَاءِ كَالنَّسْرِ فَوْقَ القِئَمَةِ السَّمَاءِ
أَزْنُو إِلَى الشَّمْسِ المِضِيئَةِ .. هَارِئًا بِالسُّحُبِ، والأَمْطَارِ، والأَنْوَاءِ
أعترف يا قلبي أنك تحب إهتزاز الثورة
على صدور الشرفاء
ووَآنَ أُمِّي هي مناضلة بل هي أجمل النساء...

PictureS Mbsm Dot Pro : www.mbsm.pro

International_Women's_Day_mbsm_dot_pro2.png (33 KB)

أعترف يا قلبي أنك تحب كل النساء
أعترف أنك لست من الحمقى ولا من الجبناء
ولست طاغوت دين يجالس السفهاء
أنت يا قلبي تعشق جنس الطيبة والوفاء
وتاجا من النور على رؤوس النبلاء
نساء صنعن بأيديهن التاريخ ولبيّن النداء
ورفعن راية المجد عالية في غياهب السماء
سَأَعِيشُ رَعْمَ الدَّاءِ والأَعْدَاءِ كَالنَّسْرِ فَوْقَ القِئَمَةِ السَّمَاءِ
أَزْنُو إِلَى الشَّمْسِ المِضِيئَةِ .. هَارِئًا بِالسُّحُبِ، والأَمْطَارِ، والأَنْوَاءِ
أعترف يا قلبي أنك تحب إهتزاز الثورة
على صدور الشرفاء
ووَآنَ أُمِّي هي مناضلة بل هي أجمل النساء...

www.mbsm.pro

يا لقي أنك تحب كل النساء
 أنت لست من الحملي ولا من الجبناء
 يا طافوت دين يجالس السفهانة
 يا لقي تمسك جنس الطيبة والوفاء
 من التور على رؤوس التبنانة
 صنعن بأيديهن التاييح والبرن النداء
 راية المجد عالاية في عياهب السعادة
 من زلفم الذم والأشياء كالنشر فوق القبة الشقانة
 في النفس المعجوبة... هاربا بالشخب، والأمعان، والأكوان
 يا لقي أنك تحب إهنازل الثورة
 سبور الشرفاء
 أي هي مناجلة بل هي أجمل النساء...
 الشاعر التونسي منير بن صالح ميلاد

International_Women's_Day_mbsm_dot_pro.jpg1.jpg (185 KB)



PictureS Mbsm Dot Pro : www.mbsm.pro

International_Women's_Day_mbsm_dot_pro.jpg1.jpg (44 KB)





www.mbsm.pro , Schema de branchement interphone acet ,interphone acet nuance audio 67620x – 67622x

written by mahdi miled | 12 August 2018

www.mbsm.pro , Schema de branchement interphone acet
,interphone acet nuance audio 67620x – 67622x

mbsmdotpro-interphone1.jpg (67 KB)



mbsmdotpro-interphone1.jpg (39 KB)



mbsmdotpro-interphone2.jpg (66 KB)



PictureS Mbsm Dot Pro ; www.mbsm.pro

mbsmdotpro-interphone2.jpg (39 KB)



mbsmdotpro-interphone3.jpg (86 KB)

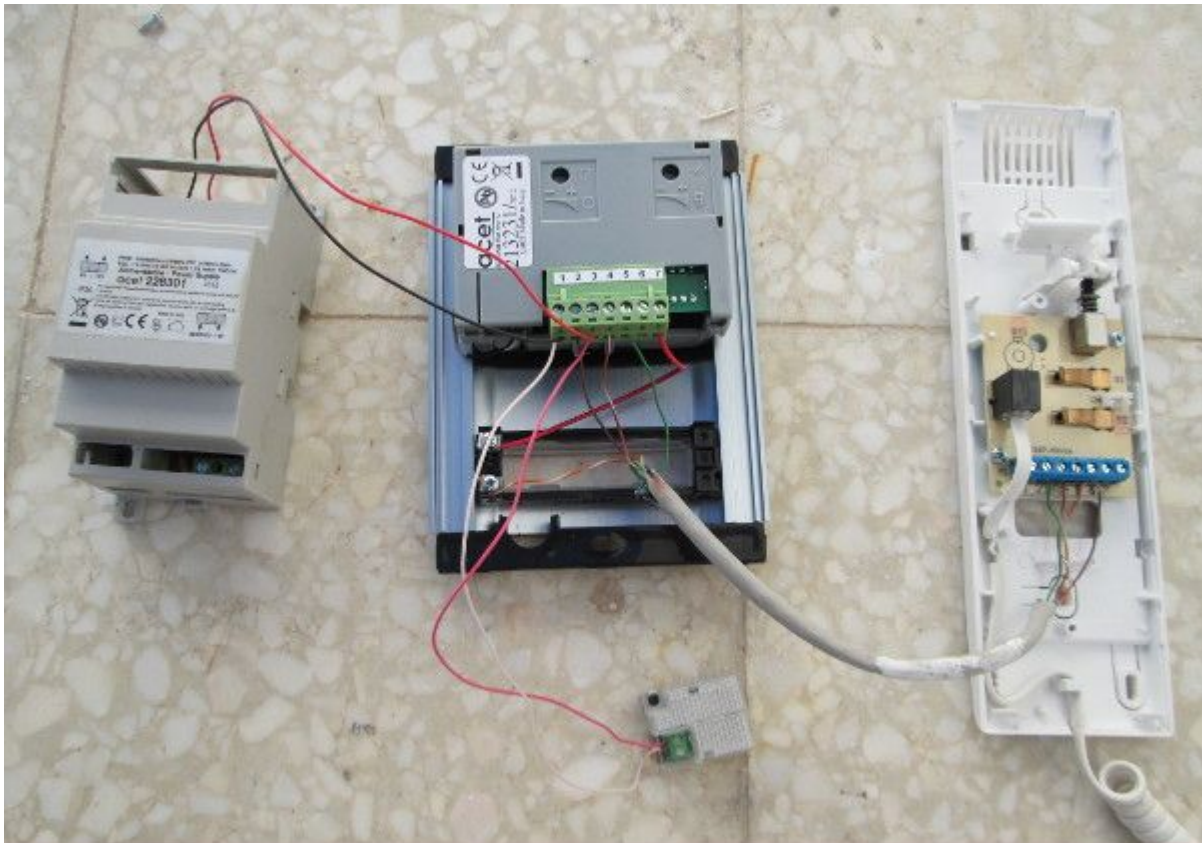

PictureS Mbsm Dot Pro ; www.mbsm.pro

mbsmdotpro-interphone3.jpg (50 KB)



mbsmdotpro-interphone4.jpg (134 KB)

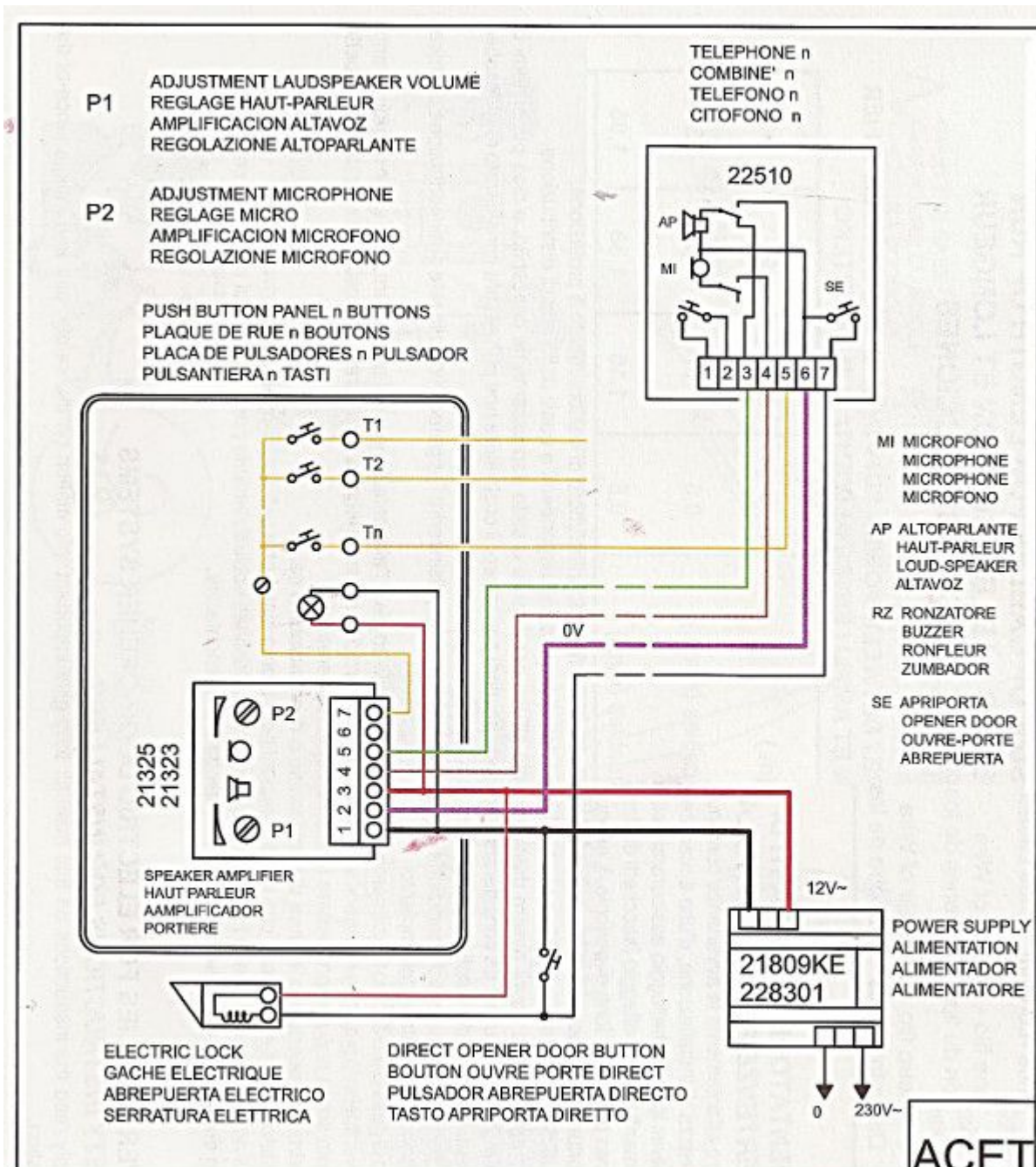

PictureS Mbsm Dot Pro : www.mbsm.pro

mbsmdotpro-interphone4.jpg (98 KB)

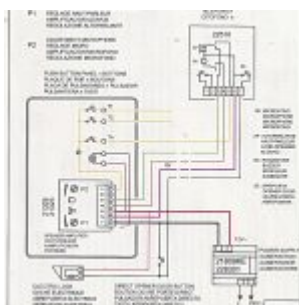

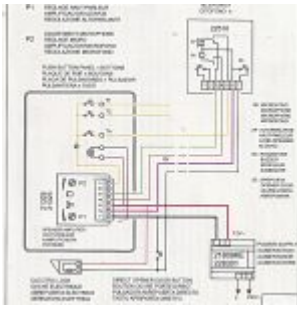

mbsmdotpro-interphone5.jpg (1 MB)

ALIMENTATION / POWER SUPPLY

le transformateur sur le mur par deux vis ou sur le guide DIN. Après avoir connecté les fils, fixer les deux ailes de protection.
 e power supply on the wall with two plugs and screws or engage it on DIN rail. After the wiring install the plastic covers over the wire terminals.

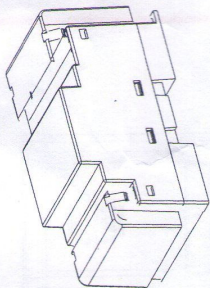

IMPORTANT : Ne pas obstruer les ouvertures de ventilation. Câbler suivant le schéma annexé. Prévoir un interrupteur pour couper le courant de l'installation. Ne pas remplacer les fusibles par d'autres de capacité différente.
IMPORTANT : Don't cover or obstruct any of the vents/sink slots. Wire exactly as the enclosed diagram. Foresee a mains breaker circuit. Don't change fuses with different types or ratings.

INSTALLATION / INSTALLATION

1) Platine de rue / Door panel

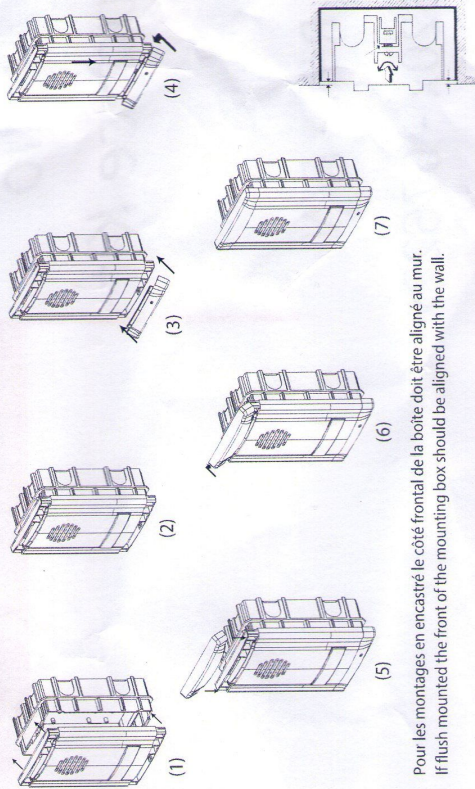

NOTE : Pour les montages en encastré le côté frontal de la boîte doit être aligné au mur.
NOTE : If flush mounted the front of the mounting box should be aligned with the wall.

2) Combiné / Doorphone

TOURNEVIS DE 3 OU 3,5 mm
 SCREWDRIVER OF 3 OR 3,5 mm

A OUVERTURE DU SOCLE
 OPEN THE BASE

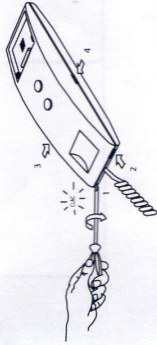

C FERMETURE DU SOCLE
 CLOSING THE BASE

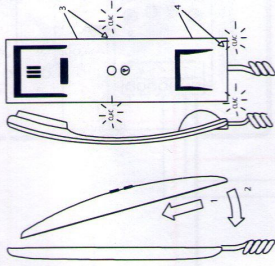

B FIXATION ET RACCORDEMENT
 FIXING AND CONNECTION

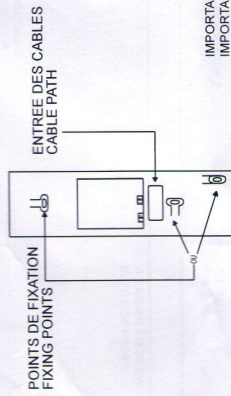

IMPORTANT : La pédale doit être bien placée avant de fermer le combiné.
IMPORTANT : Pay attention of the correct position of the hook command lever.

MODE D'EMPLOI / OPERATION

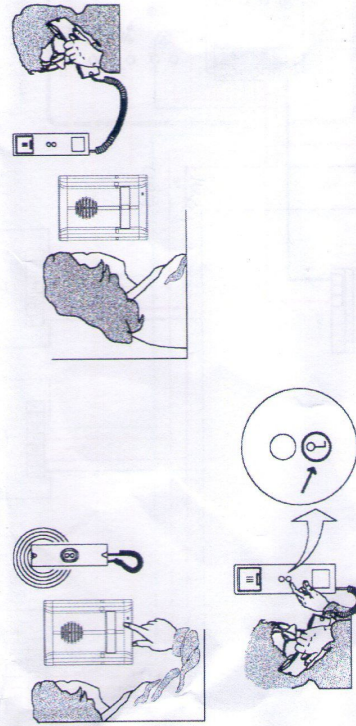

mbsmdotpro-interphone5.jpg (1 MB)



mbsmdotpro-interphone6.jpg (1 MB)

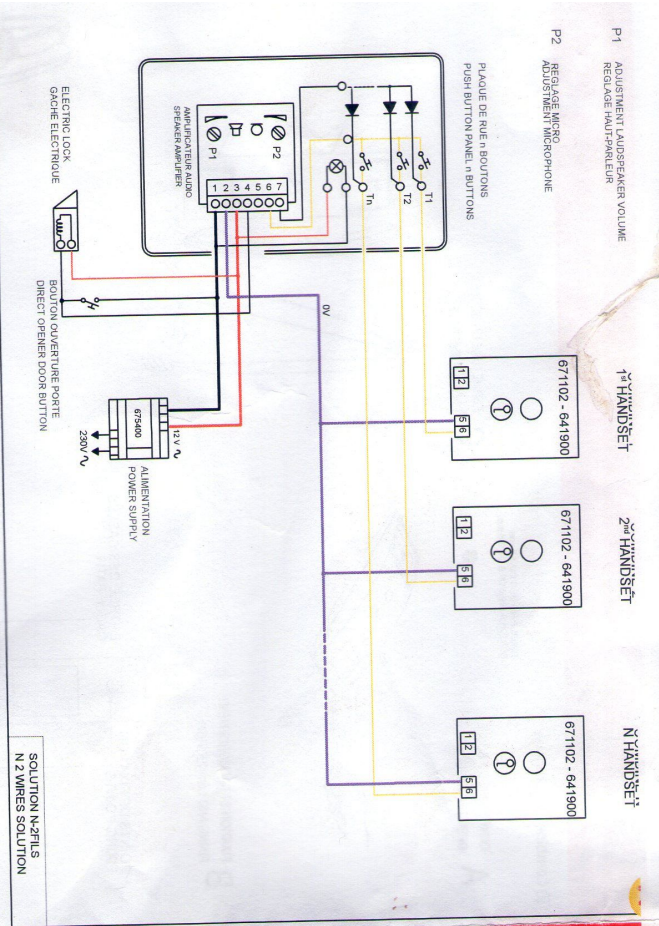

SOLUTION N.2 FILS
N.2 WIRES SOLUTION

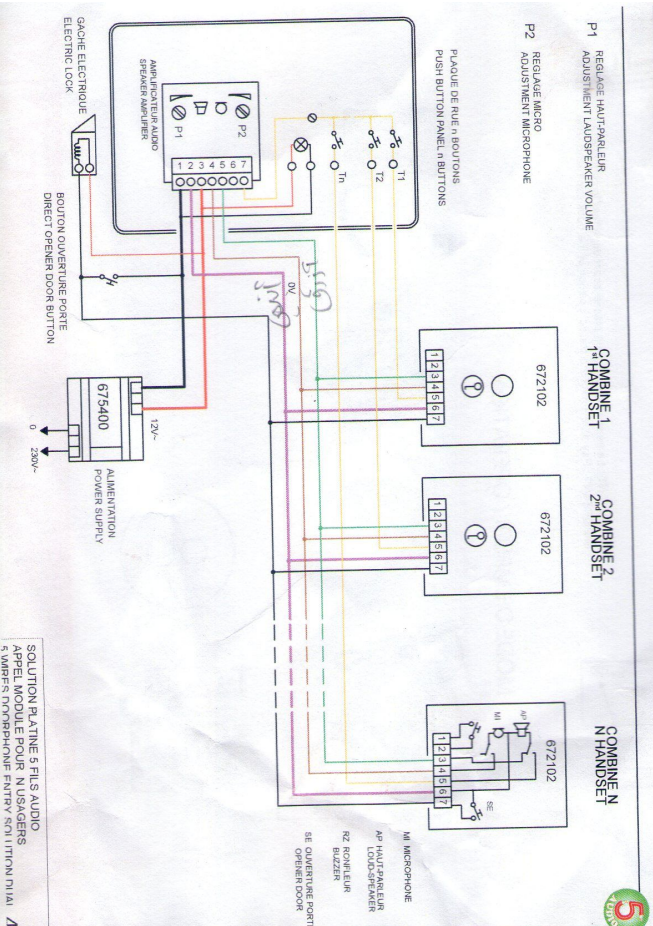

SOLUTION PLATINE 5 FILS AUDIO
APPEL MODULE POUR N.USAGERS
5 WIRE'S AUDIOPHONE-FILY SOLUTION PLAT



Kit Nuance

Audio



Audio

Nuance Kit

Réf. - P/N

67620x - 67622x



NOTICE INSTALLATEUR
INSTALLATION MANUAL



mbsmdotpro-interphone6.jpg (1 MB)



www.mbsm.pro , Contrôleur de température numérique / thermoélectrique / pour système frigorifique ou cuveuse ,STC-200+ , STC-1000+

written by mahdi miled | 12 August 2018

Le contrôleur de température de STC-200+ est conçu avec l'arrangement séparé de menu d'utilisateur et de menu d'administrateur. Les options incluses dans cette unité sont alarmantes, chauffage, et modules de frigorification. Ce capteur de la température est applicable à tous les types d'entreposage au froid qui exige la température accrue. Il est également approprié au réfrigérateur de l'eau et à la machine

de fruits de mer.

mbsmdotpro-regulateur (0).jpg (15 KB)



PictureS Mbsm Dot Pro : www.mbsm.pro

mbsmdotpro-regulateur (0).jpg (16 KB)



mbsmdotpro-regulateur (1).png (527 KB)

KI&BNT[®] STC-1000 Operation Instruction

Main function

Switch the modes between cool and heat; Control temperature by setting the temperature set value and the difference value; Temperature calibration; Refrigerating control output delay protection; Alarm when temperature exceeds temperature limit or when sensor error.

Specification and size

- ◆ Front panel size: 75(L)×34.5(W)(mm)
- ◆ Product size: 75(L)×34.5(W)×85(D)(mm)
- ◆ Mounting size: 71(L)×29(W)(mm)
- ◆ sensor length: 2m(include the probe)

Technical parameters

- ◆ Temperature measuring range: -50°C ~ 99°C
- ◆ Accuracy: ±1°C(-50°C ~ 70°C)
- ◆ Power supply: 220VAC±10%, 50/60Hz
- ◆ Sensor: NTC sensor (1PC)
- ◆ Relay contact capacity: Cool(10A/250VAC);Heat(10A/250VAC)
- ◆ Ambient temperature: 0°C ~ 60°C
- ◆ Relative humidity: 20 ~ 85% (No condensate)
- ◆ Resolution: 0.1°C
- ◆ sensor error delay: 1 minute
- ◆ Power consumption: <3W
- ◆ Storage temperature: -30°C ~ 75°C

Panel instruction

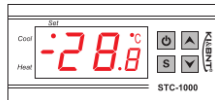

Display instruction: Three-digit LED +Minus digit + Status indicator light (Status indicator light (Cool, Heat) + Set indicator light (Set))
 Key instruction: "S" key: the key to set; "▲" key: Up key;
 "▼" key: Down key; "⏻": the key to turn on and off the power

Indicator light status instruction

Indicator light	Function	Note
Cool indicator light	On: Refrigeration starts; Off: Refrigeration stops; Flash: compressor delay	Cool, Heat indicator light can not be "on" status simultaneously
Heat indicator light	On: heating starts; Off: heating stops	
Set indicator light	On: parameter setting status	

Key operation instruction

- The way to check parameter:
 Under normal working status, press and release "▲" key once instantly, it displays temperature setting value; press and release "▼" key once instantly, it displays the difference value. It back to display the normal temperature display status in 2s.
- The way to set parameter:
 Under controller normal working status, press "S" key for 3s or more to enter parameter modifying mode, and the "Set" indicator light on, screen displays the first menu code "F1".
 Press "▲" key or "▼" key to adjust up and down and display the menu item and the code of the menu item. Press "S" key to display the parameter value of the current menu. Press both "S" key and hold "▲" key or "▼" key simultaneously to choose and adjust the parameter value of the current menu value promptly. After finishing the setting, press and release the "⏻" key instantly to save the parameter modified value and return to display the normal temperature value. If no key operation within 10 seconds, system won't save modified parameter, screen back to display normal temperature.
 Screen display "Er" if error appears during parameter saving, and back to normal working status in 3 seconds.
- Restore system data
 When electrified, system will check itself, screen will display "Er" if error exit, please press any key at this time, and it restores default value and enter into normal working mode. It is advised to reset the parameter value under such conditions.

Operation instruction

Under controller normal working status, press and hold "⏻" key for 3s can turn off the controller; Under controller "off" status, press and hold "⏻" key for 3s can turn on the controller.

Under the controller normal working status, screen displays the current measuring temperature value; also the controller can also switch the working mode between heating and cooling.

Controller starts refrigerating with cool indicator light on when the measuring temperature value ≥ temperature set value + difference value, and the refrigerating relay is connected; If the "Cool" indicator light flashes, it indicates the refrigerating equipment is under compressor delay protect status; when the measuring temperature values temperature set value, the Cool indicator light on, and refrigerating relay disconnects.

System starts heating when the measuring temperature value ≤ the temperature set value-difference value, and the "Heat" indicator light on, the heat relay connects; When the measuring temperature ≥ temperature set value, the "Heat" indicator light is off, and the heat relay disconnects.

Menu instruction

Code	Function	Set range	Default	Note
F1	Temperature set value	-50.0 ~ 99.9°C	10.0°C	
F2	Difference set value	0.3 ~ 10.0°C	0.5°C	
F3	Compressor delay time	1 ~ 10 minutes	3 minutes	
F4	Temperature calibration value	-10.0°C ~ 10.0°C	0°C	

Error description

Alarm when sensor error. Controller activate the sensor error alarm mode when sensor open circuit or short circuit, all the running status is closed off with the buzzer alarms, and the nixie tube displays "EE". press any key can cancel alarm sound, system back to display the normal temperature when the error and the fault is cleared.

Alarm when the measuring temperature exceeds temperature measuring range. Controller activates the error alarm function when the measuring temperature exceeds the temperature measuring range, all the running status is closed off with the buzzer alarms, and the nixie tube displays "HH". Press any key can cancel alarm sound, system back to display the normal working mode when the temperature restore to normal measuring range.

Safety Regulations

- ★ Danger:
 - Strictly distinguish the sensor down-lead, power wire and output relay interface from one another, and prohibit wrong connections or overloading the relay.
 - Dangers: Prohibit connecting the wire terminals without electricity cut-off.
- ★ Warning:
 - Prohibit using the machine under the environment of over damp, high temp., strong electromagnetism interference strong corrosion.
- ★ Notice:
 - The power supply should conform to the voltage value indicated in the instruction.
 - To avoid the interference, the sensor down-lead and power wire should be kept a proper distance.

Wiring diagram

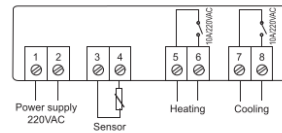

mbsmdotpro-regulateur (1).png (480 KB)

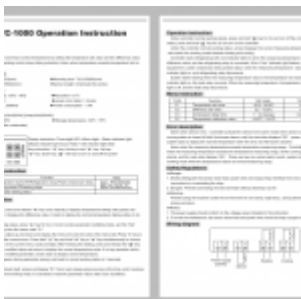
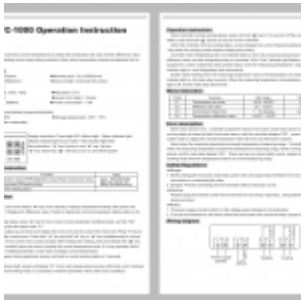

mbsmdotpro-regulateur (2).jpg (58 KB)



PictureS Mbsm Dot Pro : www.mbsm.pro

mbsmdotpro-regulateur (2).jpg (36 KB)



mbsmdotpro-regulateur (3).jpg (32 KB)

Setting item	Parameter setting range	Default	Code
Temperature differential setting	1°C~15°C	3°C	F0
Compressor delay time	0~9Minute	3Minutes	F1
Temp. lower limit setting	-40°C~set temperature	-20°C	F2
Temp. upper limit setting	Set temperature~70°C	20°C	F3
Mode optional	1: refrigeration 2:heating 3: alarm	1	F4

PictureS Mbsm Dot Pro : www.mbsm.pro

mbsmdotpro-regulateur (3).jpg (22 KB)

Parameter setting r
ng 1°C~15°C
0~9Minute
-40°C~set tempera
Set temperature~7
1: refrigeration 2:heating
-5°C~+5°C

Parameter setting r
ng 1°C~15°C
0~9Minute
-40°C~set tempera
Set temperature~7
1: refrigeration 2:heating
-5°C~+5°C

mbsmdotpro-regulateur (4).jpg (15 KB)



Picture5 Mbsm Dot Pro : www.mbsm.pro

mbsmdotpro-regulateur (4).jpg (15 KB)



mbsmdotpro-regulateur (5).jpg (124 KB)



Picture5 Mbsm Dot Pro : www.mbsm.pro

mbsmdotpro-regulateur (5).jpg (126 KB)



