

Mbsm.pro, Compressor, Embraco, FF10BKW, 1/4 hp++, 1/3 hp-, r12

written by Lilianne | 31 March 2023



Mbsm.pro, Compressor, Embraco, FF10BKW, 1/4 hp++, 1/3 hp-, r12

Mbsm.pro, compressor,

2DC-2.2Y-40S, Bitzer, semi-hermetic, h8-lsg-40x-ewl-b, 2 hp, 400 v

written by rober us | 31 March 2023

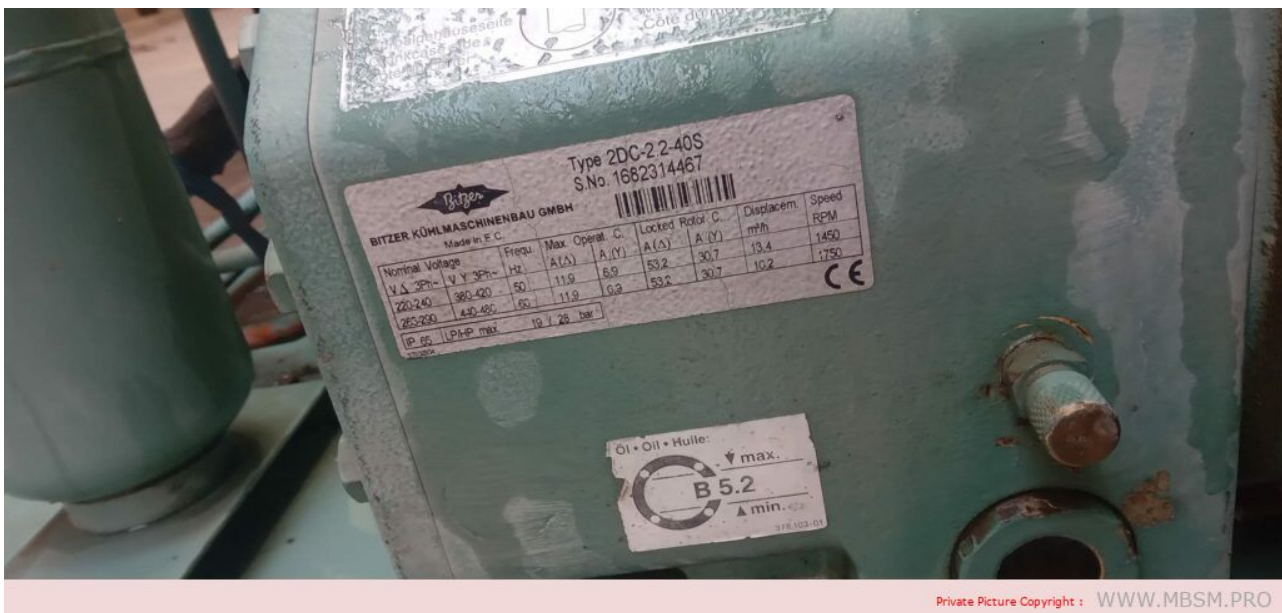

Private Picture Copyright : WWW.MBSM.PRO

Bitzer Semi-Hermetic Refrigeration Compressor 2DC-2.2Y-40S/2DES-2

Based on one technical concept, our semi-hermetic reciprocating compressors cover the entire spectrum of applications of conventional, chlorine-free HFC as well as natural refrigerants. They distinguish themselves by a robust valve plate design, a high quality and wear resistant drive gear, are easy-to-service and offer good speed control at minimum energy requirements as well as extremely smooth running. In addition, they incorporate an efficient, suction gas cooled integrated motor.

The OCTAGON series of compressors additionally excels by extremely compact dimensions and even further increased smooth running.

Model	Cond temp.	The Evaporation Temperature (R404/50HZ)											
		7.5	5	0	-5	-10	-15	-20	-25	-30	-35	-40	-45
2KC-05.2Y	40	3850	3520	2920	2390	1940	1540	1200	900	650	435	255	1000
2JC-07.2Y	40	5180	4740	3950	3260	2660	2130	1680	1290	960	675	440	240
2HC-1.2Y	40				4090	3340	2700	2140	1650	1240	890	595	345

2HC-2.2Y	40	6620	6070	5060	4190	3430	2760	2190	1700	1270	915	610	
2GC-2.2Y	40	7540	6910	5780	4790	3930	3190	2450	1990	1520	1110	775	490
2FC-2.2Y	40				5950	4900	3980	3190	2500	1920	1420	1000	650
2FC-3.2Y	40	9450	8670	7250	6020	4950	4010	3210	2520	1930	1420	1000	
2EC-2.2Y	40				7270	5980	4860	3900	3060	2350	1750	1240	810
2EC-3.2Y	40	11620	10660	8930	7420	6100	4960	3970	3120	2390	1770	1250	
2DC-2.2Y	40				8490	6980	5670	4530	3560	2720	2020	1420	920
2DC-3.2Y	40	13510	12390	10380	8610	7080	5750	4600	3610	2760	2040	1430	
2CC-3.2Y	40				10510	8650	7040	5640	4440	3420	2550	1810	1200
2CC-4.2Y	40	16470	15110	12660	10520	8660	7050	5650	4450	3420	2540	1810	
4FC-3.2Y	40				11560	9520	7740	6200	4880	3750	2790	1980	1310
4FC-5.2Y	40	18240	16740	14026	11650	9580	7790	6240	4900	3760	2790	1970	
4EC-4.2Y	40				1440	11870	9650	7720	6070	4650	3450	2440	1590
4EC-6.2Y	40	23150	21250	17780	14750	12120	9840	7860	5160	4700	3470	2420	
4DC-5.2Y	40				17650	14520	11810	9460	7440	5720	4250	3010	1980
4DC-7.2Y	40	27500	25200	21100	14790	14350	11630	9270	7250	5510	4040	2800	
4CC-6.2Y	40				21100	17420	14200	11420	9030	6930	5240	3770	2540
4CC-9.2Y	40	32850	30150	25300	21100	17410	14210	11440	9050	7000	5250	3700	
4VCS-6.2Y	40				22750	18670	15140	12090	9470	7230	5320	3720	2380
4VCS-10.2Y	40	36100	33100	27600	22850	18680	15070	11950	9260	6960	5000	3350	
4TCS-8.2Y	40				27750	22800	18480	14760	11560	8830	3520	4580	2960
4TCS-12.2Y	40	43500	39580	33300	27550	22600	18260	14530	11320	8590	6270	4320	
4PCS-10.2Y	40				32300	26500	21500	17130	13400	10220	7520	5240	3350
4PCS-15.2Y	40	52200	47850	39950	33050	27050	21850	17360	13490	10190	7390	5020	
4NCS-12.2Y	40				37300	30600	24800	19810	15510	11840	8740	6120	3950
4NCS-20.2Y	40	60500	55400	46250	38200	31250	25200	20000	15530	11730	8510	5820	
4J-13.2Y	40				42800	35250	28700	23000	18150	14000	10470	7500	5020
4J-22.2Y	40	67100	61500	51500	42700	35100	25800	22800	17870	13670	10110	7120	
4H-15.2Y	40				49850	41150	33600	27100	21500	16730	12660	9420	6380
4H-25.2Y	40	77400	71000	59500	49400	409650	33000	26450	20800	19530	11800	8320	
4G-20.2Y	40				57200	47300	38700	31200	24800	19250	14540	10540	7160
4G-30.2Y	40	98100	81800	68600	57000	47000	38250	30700	24200	18610	13860	9850	
6J-22.2Y	40				63800	52600	42800	34350	27100	20900	15640	11210	7510
6J-33.2Y	40	101500	93000	77700	64300	52700	42600	33900	26400	20050	14640	10110	
6H-25.2Y	40				74000	61600	50200	40400	31900	24700	18590	13440	9130
6H-35.2Y	40	116300	1E+06	89300	74100	60900	49450	39600	31100	23800	17670	12480	
6G-30.2Y	40				84000	69300	56600	45500	36050	27900	21000	15130	10210
6G-40.2Y	40	133440	122400	102700	85400	70300	57300	46000	36300	28000	20900	14940	
6F-40.2Y	40				100900	83100	67600	54300	42800	32950	24600	17570	11680
6F-50.2Y	40	157900	145000	121700	101300	83600	68300	55000	43600	3850	25600	18620	
8GC-60.2Y	40	188400	173100	145400	121200	10000	81500	65400					
8FC-70.2Y	40	223000	204900	172100	143500	118400	96500	77400					



Copyright : WWW.MBSM.PRO



Copyright : WWW.MBSM.PRO



Private Picture Copyright : WWW.MBSM.PRO



Mbsm_dot_pro_private_PDF_2DC-2.2Y-40S

**Mbsm.pro, DANFOSS, MANEUROP,
ALTERNATOR, COMPRESSOR,
Mt80hp4, 6.6 hp, 3ph**

written by rober us | 31 March 2023

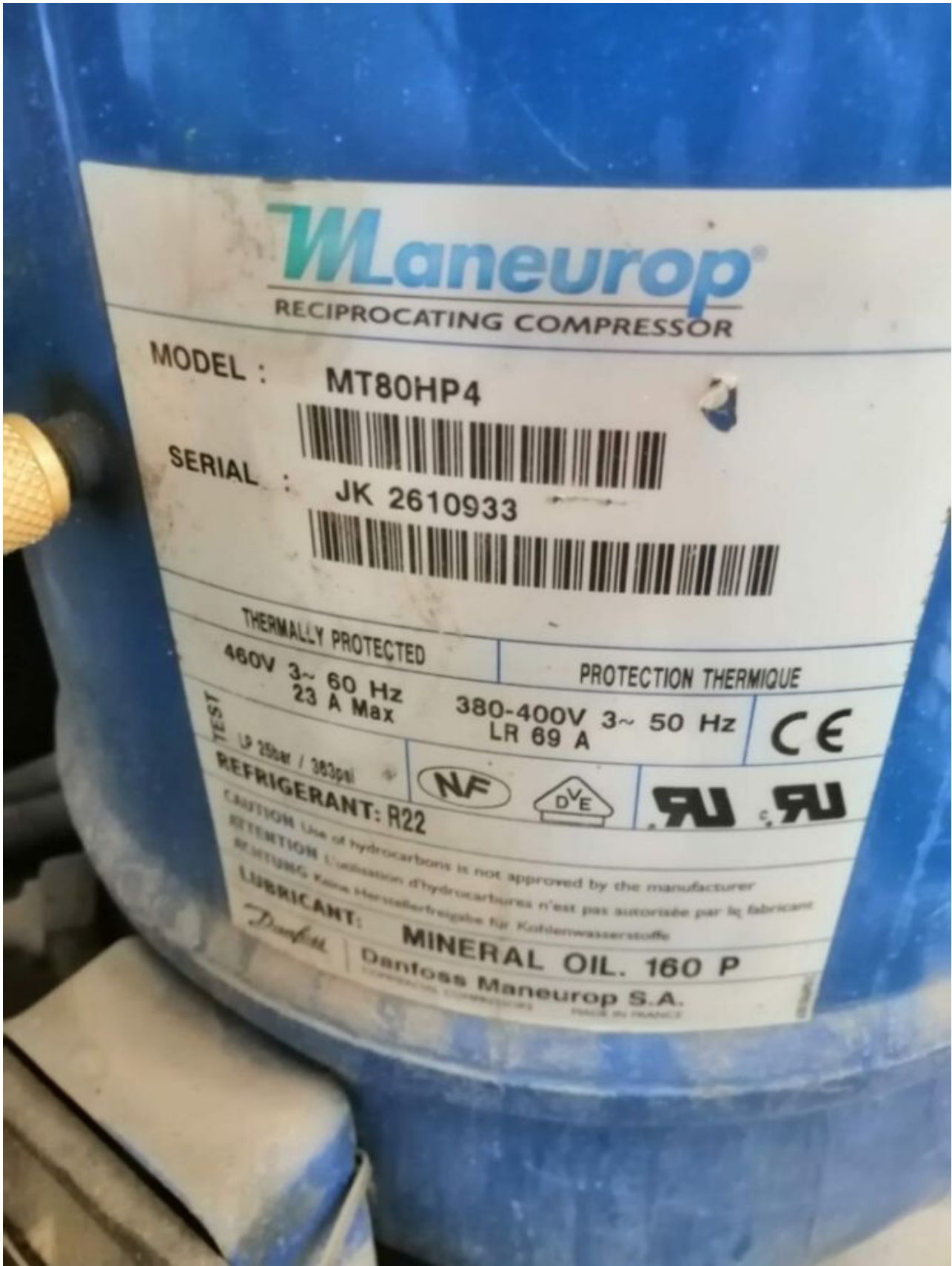

Private Picture Copyright : WWW.MBSM.PRO

DANFOSS MANEUROP ALTERNATOR COMPRESSOR



Mbsm_dot_pro_private_PDF_Mt80hp4

Model (mineral oil R22; polyolester oil R134A, R404) (MT, MTZ, NTZ SERIES)

Danfoss Maneurop MT22JC5PVE Piston Compressor (2.0HP / 1PH); [R22]

Danfoss Maneurop MT22JC4AVE piston compressor (2.0HP / 3PH); [R22]

Danfoss Maneurop MT28JC5PVE AC Compressor (2.3HP/1PH); [R22]

Danfoss Maneurop MT28JE4AVE AC Compressor (2.3HP/3PH); [R22]

Danfoss Maneurop MT32JF5MVE AC Compressor (2.6HP/1PH); [R22]

Danfoss Maneurop MT32JF4DVE AC Compressor (2.6HP/3PH); [R22]

Danfoss Maneurop MT36JG5CVE AC Compressor (3.0HP/1PH); [R22]

Danfoss Maneurop MT36JG4FVE AC Compressor (3.0HP/3PH); [R22]

Danfoss Maneurop MT40JH4EVE AC Compressor (3.3HP/3PH); [R22]

Danfoss Maneurop MT44HJ4BVE reciprocating compressor (3.6HP / 3PH); [R22]

Danfoss Maneurop MT50HK4CVE Piston Compressor (4.0HP/3PH); [R22]

Danfoss Maneurop MT56HL4BVE AC Compressor (4.6HP/3PH); [R22]

Danfoss Maneurop MT64HM4DVE AC Compressor (5.3HP/3PH); [R22]

Danfoss Maneurop MT72HN4AVE AC Compressor (6.0HP/3PH); [R22]

Danfoss Maneurop MT80HP4AVE AC Compressor (6.6HP/3PH); [R22]

Danfoss Maneurop MT100HS4DVE AC Compressor (8.3HP / 3PH); [R22]

Danfoss Maneurop MT125HU4DVE Reciprocating Compressor (10.0HP/3PH); [R22]

Danfoss Maneurop MT144HV4AVE Reciprocating Compressor (12.0HP/3PH); [R22]

Danfoss Maneurop MT160HW4EVE AC Compressor (13.3HP/3PH); [R22]

Danfoss Maneurop MTZ22JC5VE AC Compressor (2.0HP/1PH); [R134A, R404]

Danfoss Maneurop MTZ22JC4AVE AC Compressor (2.0HP/3PH); [R134A, R404]

Danfoss Maneurop MTZ28JE5AVE AC Compressor (2.3HP / 1PH); [R134A, R404]

Danfoss Maneurop MTZ28JE4AVE AC Compressor (2.3HP / 3PH); [R134A, R404]

Danfoss Maneurop MTZ32JF5AVE AC Compressor (2.6HP/1PH); [R134A, R404]

Danfoss Maneurop MTZ32JF4BVE Reciprocating Compressor (2.6HP / 3PH); [R22]

3PH); [R134A, R404]

Danfoss Maneurop MTZ36JG5AVE AC Compressor (3.0HP/1PH); [R134A, R404]

Danfoss Maneurop MTZ36JG4BVE Reciprocating Compressor (3.0HP / 3PH); [R134A, R404]

Danfoss Maneurop MTZ40JH4AVE reciprocating compressor (3.3HP / 3PH); [R134A, R404]

Danfoss Maneurop MTZ50HK4CVE Reciprocating Compressor (4.0HP / 3PH); [R134A, R404]

Danfoss Maneurop MTZ56HL4BVE Reciprocating Compressor (4.6HP / 3PH); [R134A, R404]

Danfoss Maneurop MTZ64HM4CVE Reciprocating Compressor (5.3HP / 3PH); [R134A, R404]

Danfoss Maneurop MTZ72HN4AVE Reciprocating Compressor (6.0HP/3PH); [R134A, R404]

Danfoss Maneurop MTZ80HP4AVE Reciprocating Compressor (6.6HP/3PH); [R134A, R404]

Danfoss Maneurop MTZ100HS4VE Reciprocating Compressor (8.3HP / 3PH); [R134A, R404]

Danfoss Maneurop MTZ125HU4VE Reciprocating Compressor (10.0HP/3PH); [R134A, R404]

Danfoss Maneurop MTZ144HV4AVE Reciprocating Compressor (12.0HP/3PH); [R134A, R404]

Danfoss Maneurop MTZ160HE4AVE AC Compressor (13.3HP/3PH); [R134A, R404]

Danfoss Maneurop NTZ048A4LR1A Reciprocating Compressor (2.0HP / 3PH); [R134A, R404, R507]

Danfoss Maneurop NTZ068A4LR1A Reciprocating Compressor (3.5HP / 3PH); [R134A, R404, R507]

Danfoss Maneurop NTZ096A4LR1A Reciprocating Compressor (4.5HP / 3PH); [R134A, R404, R507]

Danfoss Maneurop NTZ108A4LR1A AC Compressor (5.0HP / 3PH); [R134A, R404, R507]

Danfoss Maneurop NTZ136A4LR1A Reciprocating Compressor (6.5HP / 3PH); [R134A, R404, R507]

Danfoss Maneurop NTZ215A4LR1A Reciprocating Compressor (10.0HP / 3PH); [R134A, R404, R507]

Danfoss Maneurop NTZ271A4LR1A Piston Compressor (13.0HP / 3PH); [R134A, R404, R507]

Mbsm.pro, Compressor, DkLP-15x-EwL, Dwm copeland, 1/5 hp, Copeland™ Semi-Hermetic Compressors, 3 ph

written by rober us | 31 March 2023



Private Picture Copyright : WWW.MBSM.PRO

Mbsm.pro, Compressor, DkLP-15x-EwL, Dwm copeland, 1/5 hp, Copeland™ Semi-Hermetic Compressors, 3 ph



Copyright : WWW.MBSM.PRO

Mbsm_dot_pro_private_PDF_DkLP-15x-EwL



Private Picture Copyright : WWW.MBSM.PRO

Mbsm.pro, Compressor, Embraco, Fractional, Domestic, Compressor Data, EMU45HSC, 1/6 hp, 1bp

written by rober us | 31 March 2023



Private Picture Copyright : WWW.MBSM.PRO

Embraco Fractional Domestic Compressor Data

Embraco/Embraco R134a series EMU45HSC

Wholesale and Retail Embraco/Embraco Compressor, Embraco/Embraco Piston Compressor Model: emu45hsc, Refrigerant: R134a, Supply Voltage: 220-240V, 50-60Hz, Horsepower: 1/6 HP, Provide Embraco / Embraco emu45hsc models, specifications, parameters, pictures, prices and other data. Embraco, a company focused on refrigeration solutions, is the leader in the hermetic compressor market

Product model: EMU45HSC

Refrigerant: R134a

Power frequency: 50/60Hz

Power supply voltage: 220-240V

Product horsepower: 1/6 HP

Model	Refrigerator	Voltage	Frequency / Rotation	Application	HP	Efficiency (Kcal/wh)	Capacity (Kcal/h)	Displacement (cm ³)	Type of oil	Type of motor	Starting torque	Type of test
EMI30HER	R-134a	115-127 V 60 Hz 1 ~	60 Hz	LBP	1/10	0,92	69	3	IS022	RSIR-CSIR	LST	ASHRAE32
EMIE30HJR	R-134a	115-127 V 60 Hz 1 ~	60 Hz	LBP	1/10	1,03	76	2,83	IS010	RSIR	LST	ASHRAE32
EMI30HER	R-134a	115-127 V 60 Hz 1 ~	60 Hz	LBP	1/10	1,03	77	3	IS010	RSIR-CSIR	LST	ASHRAE32
EM30HNR	R-134a	115-127 V 60 Hz 1 ~	60 Hz	LBP	1/10	0,93	77	3	IS022	RSIR-CSIR	LST	ASHRAE32
EM30HHR	R-134a	115 V 60 Hz 1 ~	60 Hz	LBP	1/10	0,81	78	3	IS022	CSIR	LST	ASHRAE32
EM30HHR	R-134a	115 V 60 Hz 1 ~	60 Hz	LBP	1/10	0,81	78	3	IS022	RSIR	LST	ASHRAE32
EM30HHR	R-134a	115 V 60 Hz 1 ~	60 Hz	LBP	1/10	0,81	78	3	IS022	RSIR-CSIR	LST	ASHRAE32
EMT30HSC	R-134a	115 V 60 Hz 1 ~	60 Hz	LBP	1/10	1,08	78	3	IS010	RSCR – 12 μF	LST	ASHRAE32
EMI28HER	R-134a	115-127 V 60 Hz 1 ~	60 Hz	LBP	1/10	1,01	81	3	IS010	RSIR-CSIR	LST	ASHRAE32
EMU30HSC	R-134a	115 V 60 Hz 1 ~	60 Hz	LBP	1/10	1,21	83	3	IS010	RSCR – 12 μF	LST	ASHRAE32
EMI40HNR	R-134a	115-127 V 60 Hz 1 ~	60 Hz	LBP	1/10	1,05	94	3,77	IS010	RSIR-CSIR	LST	ASHRAE32
EMI45HER	R-134a	115-127 V 60 Hz 1 ~	60 Hz	LBP	1/8	1,13	106	3,77	IS010	RSIR	LST	ASHRAE32

EMI45HER	R-134a	115-127 V 60 Hz 1 ~	60 Hz	LBP	1/8	1,08	106	3,77	IS022	RSIR	LST	ASHRAE32
EM45HNR	R-134a	115-127 V 60 Hz 1 ~	60 Hz	LBP	1/8	1	106	3,77	IS010	RSIR-CSIR	LST	ASHRAE32
EM45HNR	R-134a	115-127 V 60 Hz 1 ~	60 Hz	LBP	1/8	0,98	106	3,77	IS022	RSIR-CSIR	LST	ASHRAE32
EMU45HEP	R-134a	100 V 50-60 Hz 1 ~	60 Hz	LBP	1/6	1,14	110	3,77	IS010	RSIR	LST	ASHRAE32
EMU45HER	R-134a	115-127 V 60 Hz 1 ~	60 Hz	LBP	1/8	1,19	113	3,77	IS07	RSIR	LST	ASHRAE32
EMU45HSC	R-134a	115-127 V 60 Hz 1 ~	60 Hz	LBP	1/6	1,22	113	3,77	IS010	RSCR – 20 μF	LST	ASHRAE32
EMU45HSC	R-134a	115-127 V 60 Hz 1 ~	60 Hz	LBP	1/6	1,25	113	3,77	IS010	RSCR – 15 μF	LST	ASHRAE32
EMU45HSC	R-134a	115-127 V 60 Hz 1 ~	60 Hz	LBP	1/6	1,25	113	3,77	IS010	RSCR – 12 μF	LST	ASHRAE32
EMI30HER	R-134a	115-127 V 60 Hz 1 ~	60 Hz	LBP	1/10	0,92	69	3	IS022	RSIR-CSIR	LST	ASHRAE32
EMIE30HJR	R-134a	115-127 V 60 Hz 1 ~	60 Hz	LBP	1/10	1,03	76	2,83	IS010	RSIR	LST	ASHRAE32
EMI30HER	R-134a	115-127 V 60 Hz 1 ~	60 Hz	LBP	1/10	1,03	77	3	IS010	RSIR-CSIR	LST	ASHRAE32
EM30HNR	R-134a	115-127 V 60 Hz 1 ~	60 Hz	LBP	1/10	0,93	77	3	IS022	RSIR-CSIR	LST	ASHRAE32
EM30HHR	R-134a	115 V 60 Hz 1 ~	60 Hz	LBP	1/10	0,81	78	3	IS022	CSIR	LST	ASHRAE32
EM30HHR	R-134a	115 V 60 Hz 1 ~	60 Hz	LBP	1/10	0,81	78	3	IS022	RSIR	LST	ASHRAE32
EM30HHR	R-134a	115 V 60 Hz 1 ~	60 Hz	LBP	1/10	0,81	78	3	IS022	RSIR-CSIR	LST	ASHRAE32
EMT30HSC	R-134a	115 V 60 Hz 1 ~	60 Hz	LBP	1/10	1,08	78	3	IS010	RSCR – 12 μF	LST	ASHRAE32
EMI28HER	R-134a	115-127 V 60 Hz 1 ~	60 Hz	LBP	1/10	1,01	81	3	IS010	RSIR-CSIR	LST	ASHRAE32
EMU30HSC	R-134a	115 V 60 Hz 1 ~	60 Hz	LBP	1/10	1,21	83	3	IS010	RSCR – 12 μF	LST	ASHRAE32
EMI40HNR	R-134a	115-127 V 60 Hz 1 ~	60 Hz	LBP	1/10	1,05	94	3,77	IS010	RSIR-CSIR	LST	ASHRAE32
EMI45HER	R-134a	115-127 V 60 Hz 1 ~	60 Hz	LBP	1/8	1,13	106	3,77	IS010	RSIR	LST	ASHRAE32
EMI45HER	R-134a	115-127 V 60 Hz 1 ~	60 Hz	LBP	1/8	1,08	106	3,77	IS022	RSIR	LST	ASHRAE32
EM45HNR	R-134a	115-127 V 60 Hz 1 ~	60 Hz	LBP	1/8	1	106	3,77	IS010	RSIR-CSIR	LST	ASHRAE32

EM45HNR	R-134a	115-127 V 60 Hz 1 ~	60 Hz	LBP	1/8	0,98	106	3,77	IS022	RSIR-CSIR	LST	ASHRAE32
EMU45HEP	R-134a	100 V 50-60 Hz 1 ~	60 Hz	LBP	1/6	1,14	110	3,77	IS010	RSIR	LST	ASHRAE32
EMU45HER	R-134a	115-127 V 60 Hz 1 ~	60 Hz	LBP	1/8	1,19	113	3,77	IS07	RSIR	LST	ASHRAE32
EMU45HSC	R-134a	115-127 V 60 Hz 1 ~	60 Hz	LBP	1/6	1,22	113	3,77	IS010	RSCR – 20 μF	LST	ASHRAE32
EMU45HSC	R-134a	115-127 V 60 Hz 1 ~	60 Hz	LBP	1/6	1,25	113	3,77	IS010	RSCR – 15 μF	LST	ASHRAE32
EMU45HSC	R-134a	115-127 V 60 Hz 1 ~	60 Hz	LBP	1/6	1,25	113	3,77	IS010	RSCR – 12 μF	LST	ASHRAE32
EMY45HER	R-134a	115-127 V 60 Hz 1 ~	60 Hz	LBP	1/6	1,22	115	3,77	IS010	RSIR	LST	ASHRAE32
EMY45HSC	R-134a	115-127 V 60 Hz 1 ~	60 Hz	LBP	1/8	1,33	115	3,77	IS010	RSCR – 12 μF	LST	ASHRAE32
EM2U50HLP	R-134a	115-127 V 60 Hz 1 ~	60 Hz	LBP	1/6	1,2	126	4,5	IS010	RSIR	LST	ASHRAE32
EM55HNR	R-134a	115-127 V 60 Hz 1 ~	60 Hz	LBP	1/6	1,02	129	4,6	IS022	RSIR-CSIR	LST	ASHRAE32
EM55HNX	R-134a	115-127 V 60 Hz 1 ~	60 Hz	LBP	1/6	1,01	129	4,6	IS022	CSIR	HST	ASHRAE32
EMI55HER	R-134a	115-127 V 60 Hz 1 ~	60 Hz	LBP	1/6	1,12	129	4,6	IS022	RSIR-CSIR	LST	ASHRAE32
EM2Y50HLT	R-134a	115-127 V 60 Hz 1 ~	60 Hz	LBP	1/6	1,42	130	4,5	IS010	RSCR – 12 μF	LST	ASHRAE32
EM2Y50HLT	R-134a	115-127 V 60 Hz 1 ~	60 Hz	LBP	1/6	1,42	130	4,5	IS010	RSCR – 15 μF	LST	ASHRAE32
EM3U50HLP	R-134a	115-127 V 60 Hz 1 ~	60 Hz	LBP	1/5	1,35	140	4,5	IS010	RSIR	LST	ASHRAE32
EMI60HEP	R-134a	100 V 50-60 Hz 1 ~	60 Hz	LBP	1/6	1,09	141	4,99	IS022	RSIR	LST	ASHRAE32
EMI60HER	R-134a	115-127 V 60 Hz 1 ~	60 Hz	LBP	1/6	1,06	144	4,99	IS022	RSIR-CSIR	LST	ASHRAE32
EMI60HEP	R-134a	100 V 50-60 Hz 1 ~	60 Hz	LBP	1/6	1,14	144	4,99	IS010	RSIR	LST	ASHRAE32
NEK2116Z	R-134a	115 V 60 Hz 1~	60 Hz	LBP	1/5	0,79	147	7,37	IS022	CSIR	HST	ARI4
EMU60HSC	R-134a	115-127 V 60 Hz 1 ~	60 Hz	LBP	1/4	1,25	149	4,99	IS010	RSCR – 12 μF	LST	ASHRAE32
EGD60HLC	R-134a	115-127 V 60 Hz 1 ~	60 Hz	LBP	1/5	1,5	149	5,17	IS010	RSCR – 12 μF	LST	ASHRAE32
EGD60HLC	R-134a	115-127 V 60 Hz 1 ~	60 Hz	LBP	1/5	1,54	149	5,17	IS010	RSCR – 12 μF	LST	ASHRAE32

EGZS60HLP	R-134a	115-127 V 60 Hz 1 ~	60 Hz	LBP	1/5	1,46	150	5,09	IS010	RSCR – 12 μF	LST	ASHRAE32
EGZS60HLP	R-134a	115-127 V 60 Hz 1 ~	60 Hz	LBP	1/5	1,46	150	5,09	IS010	RSCR – 15 μF	LST	ASHRAE32
EGZS60HLP	R-134a	115-127 V 60 Hz 1 ~	60 Hz	LBP	1/5	1,46	150	5,09	IS010	RSCR – 20 μF	LST	ASHRAE32
EMY60HSC	R-134a	115-127 V 60 Hz 1 ~	60 Hz	LBP	1/6	1,36	152	4,99	IS010	RSCR – 12 μF	LST	ASHRAE32
EMYS60HEP	R-134a	115-127 V 60 Hz 1 ~	60 Hz	LBP	1/5+	1,29	153	5,19	IS010	RSCR – 12 μF	LST	ASHRAE32
EMY60HER	R-134a	115-127 V 60 Hz 1 ~	60 Hz	LBP	1/6	1,27	154	4,99	IS010	RSIR	LST	ASHRAE32
EMY60HSC	R-134a	115-127 V 60 Hz 1 ~	60 Hz	LBP	1/6	1,34	154	4,99	IS010	RSCR – 12 μF	LST	ASHRAE32
EGZS60HLP	R-134a	115-127 V 60 Hz 1 ~	60 Hz	LBP	1/5	1,48	154	5,09	IS010	RSCR – 12 μF	LST	ASHRAE32
EGZS60HLP	R-134a	115-127 V 60 Hz 1 ~	60 Hz	LBP	1/5	1,48	154	5,09	IS010	RSCR – 15 μF	LST	ASHRAE32
EGZS60HLP	R-134a	115-127 V 60 Hz 1 ~	60 Hz	LBP	1/5	1,48	154	5,09	IS010	RSCR – 20 μF	LST	ASHRAE32
EGZS60HLP	R-134a	115-127 V 60 Hz 1 ~	60 Hz	LBP	1/5	1,51	154	5,09	IS010	RSCR – 12 μF	LST	ASHRAE32
EGZS60HLP	R-134a	115-127 V 60 Hz 1 ~	60 Hz	LBP	1/5	1,51	154	5,09	IS010	RSCR – 15 μF	LST	ASHRAE32
EGZS60HLP	R-134a	115-127 V 60 Hz 1 ~	60 Hz	LBP	1/5	1,51	154	5,09	IS010	RSCR – 20 μF	LST	ASHRAE32
EGZS60HLP	R-134a	115-127 V 60 Hz 1 ~	60 Hz	LBP	1/5	1,52	154	5,09	IS07	RSCR – 12 μF	LST	ASHRAE32
EGZS60HLP	R-134a	115-127 V 60 Hz 1 ~	60 Hz	LBP	1/5	1,52	154	5,09	IS07	RSCR – 15 μF	LST	ASHRAE32
EGZS60HLP	R-134a	115-127 V 60 Hz 1 ~	60 Hz	LBP	1/5	1,52	154	5,09	IS07	RSCR – 20 μF	LST	ASHRAE32
EGX60HLC	R-134a	115-127 V 60 Hz 1 ~	60 Hz	LBP	1/5	1,53	154	5,09	IS010	RSCR – 12 μF	LST	ASHRAE32
ONE 60HLP	R-134a	115-127 V 60 Hz 1 ~	60 Hz	LBP	1/5	1,4	154	5,09	IS010	RSIR	LST	ASHRAE32
ONE 60HLP	R-134a	115-127 V 60 Hz 1 ~	60 Hz	LBP	1/5	1,41	154	5,09	IS07	RSIR	LST	ASHRAE32
FF7,5HBK	R-134a	115 V 60 Hz 1 ~	60 Hz	LBP	1/5+	0,94	159	6,92	IS022	RSIR-CSIR	LST	ASHRAE32
EM2U60HLP	R-134a	115-127 V 60 Hz 1 ~	60 Hz	LBP	1/5	1,32	162	5,54	IS010	RSCR – 12 μF	LST	ASHRAE32
EM2U60HLP	R-134a	115-127 V 60 Hz 1 ~	60 Hz	LBP	1/5	1,26	162	5,54	IS010	RSIR	LST	ASHRAE32

EMH60HER	R-134a	115-127 V 60 Hz 1 ~	60 Hz	LBP	1/4	1,27	163	5,19	IS07	RSIR	LST	ASHRAE32
EM3D60HLT	R-134a	115-127 V 60 Hz 1 ~	60 Hz	LBP	1/4	1,58	163	5,19	IS010	RSCR – 12 μF	LST	ASHRAE32
EM3D60HLT	R-134a	115-127 V 60 Hz 1 ~	60 Hz	LBP	1/4	1,58	163	5,19	IS010	RSCR – 15 μF	LST	ASHRAE32
EM65HNR	R-134a	115-127 V 60 Hz 1 ~	60 Hz	LBP	1/6+	0,99	164	5,54	IS010	RSIR-CSIR	LST	ASHRAE32
EM65HNR	R-134a	115-127 V 60 Hz 1 ~	60 Hz	LBP	1/6+	0,98	164	5,54	IS022	RSIR-CSIR	LST	ASHRAE32
EM2Y60HLP	R-134a	115-127 V 60 Hz 1 ~	60 Hz	LBP	1/4	1,44	165	5,54	IS010	RSCR – 12 μF	LST	ASHRAE32
EGD70HLC	R-134a	115-127 V 60 Hz 1 ~	60 Hz	LBP	1/4	1,56	169	5,64	IS010	RSCR – 12 μF	LST	ASHRAE32
EM2Z60HLT	R-134a	115-127 V 60 Hz 1 ~	60 Hz	LBP	1/5	1,48	170	5,54	IS010	RSCR – 12 μF	LST	ASHRAE32
EM2Z60HLT	R-134a	115-127 V 60 Hz 1 ~	60 Hz	LBP	1/5	1,48	170	5,54	IS010	RSCR – 15 μF	LST	ASHRAE32
FFV6HAK	R-134a	115-127 V 60 Hz 1 ~	60 Hz	LBP	1/5	1,19	170	6,23	IS022	RSIR-CSIR	LST	ASHRAE32
FEE6HAK	R-134a	115-127 V 60 Hz 1 ~	60 Hz	LBP	1/5	1,07	171	6,23	IS022	RSIR-CSIR	LST	ASHRAE32
EMY70HER	R-134a	115-127 V 60 Hz 1 ~	60 Hz	LBP	1/5	1,21	171	5,72	IS010	RSIR-CSIR	LST	ASHRAE32
EMYE70HEP	R-134a	115-127 V 60 Hz 1 ~	60 Hz	LBP	1/5	1,31	173	5,96	IS010	RSIR	LST	ASHRAE32
EMYE70HEP	R-134a	115-127 V 60 Hz 1 ~	60 Hz	LBP	1/5	1,37	173	5,96	IS010	RSIR-RSCR – 12 μF	LST	ASHRAE32
EMYE70HEP	R-134a	115-127 V 60 Hz 1 ~	60 Hz	LBP	1/5	1,37	173	5,96	IS010	RSIR-RSCR – 15 μF	LST	ASHRAE32
EMYE70HEP	R-134a	115-127 V 60 Hz 1 ~	60 Hz	LBP	1/5	1,3	173	5,96	IS010	RSIR	LST	ASHRAE32
EGAS70HLR	R-134a	115-127 V 60 Hz 1 ~	60 Hz	LBP	1/5+	1,29	174	5,56	IS010	RSIR	LST	ASHRAE32
FGS70HA	R-134a	100 V 50-60 Hz 1 ~	60 Hz	LBP	1/5+	1,32	174	6,36	IS010	RSCR – 20 μF	LST	ASHRAE32
EMX70HSC	R-134a	115-127 V 60 Hz 1 ~	60 Hz	LBP	1/5+	1,44	175	5,96	IS010	RSCR – 12 μF	LST	ASHRAE32
EGX70HLC	R-134a	115-127 V 60 Hz 1 ~	60 Hz	LBP	1/4	1,55	175	5,56	IS010	RSCR – 15 μF	LST	ASHRAE32
EGX70HLC	R-134a	115-127 V 60 Hz 1 ~	60 Hz	LBP	1/4	1,56	175	5,56	IS010	RSCR – 12 μF	LST	ASHRAE32
EGX70HLC	R-134a	115-127 V 60 Hz 1 ~	60 Hz	LBP	1/4	1,57	175	5,56	IS07	RSCR – 15 μF	LST	ASHRAE32

EGX70HLC	R-134a	115-127 V 60 Hz 1 ~	60 Hz	LBP	1/4	1,58	175	5,56	IS07	RSCR – 12 μF	LST	ASHRAE32
EGZS70HLP	R-134a	115-127 V 60 Hz 1 ~	60 Hz	LBP	1/4	1,54	175	5,56	IS07	RSCR – 12 μF	LST	ASHRAE32
EGZS70HLP	R-134a	115-127 V 60 Hz 1 ~	60 Hz	LBP	1/4	1,54	175	5,56	IS07	RSCR – 15 μF	LST	ASHRAE32
EGZS70HLP	R-134a	115-127 V 60 Hz 1 ~	60 Hz	LBP	1/4	1,54	175	5,56	IS07	RSCR – 20 μF	LST	ASHRAE32
ONE 70HLP	R-134a	115-127 V 60 Hz 1 ~	60 Hz	LBP	1/4	1,43	175	5,56	IS010	RSIR	LST	ASHRAE32
ONE 70HLP	R-134a	115-127 V 60 Hz 1 ~	60 Hz	LBP	1/4	1,44	175	5,56	IS07	RSIR	LST	ASHRAE32
ONE 70HLP	R-134a	115-127 V 60 Hz 1 ~	60 Hz	LBP	1/4	1,39	176	5,56	IS010	RSIR	LST	ASHRAE32
FF8,5HBK	R-134a	115-127 V 60 Hz 1 ~	60 Hz	LBP	1/4	0,94	186	7,95	IS022	RSIR-CSIR	LST	ASHRAE32
FFU70HAK	R-134a	115-127 V 60 Hz 1 ~	60 Hz	LBP	1/4	1,29	189	6,36	IS010	RSIR-CSIR	LST	ASHRAE32
EM3Z70HLT	R-134a	115-127 V 60 Hz 1 ~	60 Hz	LBP	1/4+	1,5	189	5,96	IS010	RSCR – 12 μF	LST	ASHRAE32
EM3Z70HLT	R-134a	115-127 V 60 Hz 1 ~	60 Hz	LBP	1/4+	1,5	189	5,96	IS010	RSCR – 15 μF	LST	ASHRAE32
EM3D70HLT	R-134a	115-127 V 60 Hz 1 ~	60 Hz	LBP	1/4+	1,57	193	5,96	IS010	RSCR – 12 μF	LST	ASHRAE32
EM3D70HLT	R-134a	115-127 V 60 Hz 1 ~	60 Hz	LBP	1/4+	1,57	193	5,96	IS010	RSCR – 15 μF	LST	ASHRAE32
FFI7,5HAK	R-134a	115 V 60 Hz 1 ~	60 Hz	LBP	1/4	1,16	193	6,76	IS022	RSIR-CSIR	LST	ASHRAE32
EM2U80HLP	R-134a	115-127 V 60 Hz 1 ~	60 Hz	LBP	1/4	1,32	197	6,76	IS010	RSIR	LST	ASHRAE32
EM2U80HLP	R-134a	115-127 V 60 Hz 1 ~	60 Hz	LBP	1/4	1,32	197	6,76	IS010	RSCR – 12 μF	LST	ASHRAE32
EM2U80HLP	R-134a	115-127 V 60 Hz 1 ~	60 Hz	LBP	1/4	1,32	197	6,76	IS010	RSCR – 15 μF	LST	ASHRAE32
EM2U80HLP	R-134a	115-127 V 60 Hz 1 ~	60 Hz	LBP	1/4	1,46	199	6,76	IS010	RSCR – 12 μF	LST	ASHRAE32
EM2U80HLP	R-134a	115-127 V 60 Hz 1 ~	60 Hz	LBP	1/4	1,46	199	6,76	IS010	RSCR – 15 μF	LST	ASHRAE32
EM2U80HLP	R-134a	115-127 V 60 Hz 1 ~	60 Hz	LBP	1/4	1,42	199	6,76	IS010	RSIR	LST	ASHRAE32
EGUS80HLP	R-134a	115-127 V 60 Hz 1 ~	60 Hz	LBP	1/4	1,38	203	6,36	IS010	RSIR	LST	ASHRAE32
EGD80HLC	R-134a	115-127 V 60 Hz 1 ~	60 Hz	LBP	1/4	1,59	204	6,44	IS010	RSCR – 12 μF	LST	ASHRAE32

EGAS80HLP	R-134a	115-127 V 60 Hz 1 ~	60 Hz	LBP	1/4	1,24	204	6,44	IS010	RSIR	LST	ASHRAE32
EGAS80HLR	R-134a	115-127 V 60 Hz 1 ~	60 Hz	LBP	1/4+	1,32	205	6,36	IS010	RSIR-CSIR	LST	ASHRAE32
EGX80HLC	R-134a	115-127 V 60 Hz 1 ~	60 Hz	LBP	1/4	1,55	205	6,36	IS010	RSCR – 12 μF	LST	ASHRAE32
EM2Z80HLT	R-134a	115-127 V 60 Hz 1 ~	60 Hz	LBP	1/4	1,51	205	6,76	IS010	RSCR – 12 μF	LST	ASHRAE32
EM2Z80HLT	R-134a	115-127 V 60 Hz 1 ~	60 Hz	LBP	1/4	1,51	205	6,76	IS010	RSCR – 15 μF	LST	ASHRAE32
ONE 80HLP	R-134a	115-127 V 60 Hz 1 ~	60 Hz	LBP	1/4	1,44	207	6,36	IS010	RSIR	LST	ASHRAE32
EGX80HLC	R-134a	115-127 V 60 Hz 1 ~	60 Hz	LBP	1/4	1,55	207	6,36	IS010	RSCR – 12 μF	LST	ASHRAE32
EGX80HLC	R-134a	115-127 V 60 Hz 1 ~	60 Hz	LBP	1/4	1,57	207	6,36	IS010	RSCR – 15 μF	LST	ASHRAE32
EGX80HLC	R-134a	115-127 V 60 Hz 1 ~	60 Hz	LBP	1/4	1,59	207	6,36	IS07	RSCR – 15 μF	LST	ASHRAE32
EGX80HLC	R-134a	115-127 V 60 Hz 1 ~	60 Hz	LBP	1/4	1,59	207	6,36	IS07	RSCR – 12 μF	LST	ASHRAE32
FFI8,5HAK	R-134a	115-127 V 60 Hz 1 ~	60 Hz	LBP	1/4+	1,18	209	7,15	IS022	RSIR-CSIR	LST	ASHRAE32
FF10HBX	R-134a	115 V 60 Hz 1 ~	60 Hz	LBP	1/4+	0,98	212	9,04	IS022	CSIR	HST	ASHRAE32
EGUS90HLP	R-134a	115-127 V 60 Hz 1 ~	60 Hz	LBP	1/4+	1,42	234	7,15	IS010	RSIR	LST	ASHRAE32
ONE 90HLP	R-134a	115-127 V 60 Hz 1 ~	60 Hz	LBP	1/4+	1,45	236	7,15	IS010	RSIR	LST	ASHRAE32
EGAS90HLR	R-134a	115-127 V 60 Hz 1 ~	60 Hz	LBP	1/3-	1,37	236	7,15	IS010	RSIR-CSIR	LST	ASHRAE32
EGX90HLC	R-134a	115-127 V 60 Hz 1 ~	60 Hz	LBP	1/4+	1,58	239	7,15	IS07	RSCR – 15 μF	LST	ASHRAE32
EGX90HLC	R-134a	115-127 V 60 Hz 1 ~	60 Hz	LBP	1/4+	1,58	239	7,15	IS07	RSCR – 12 μF	LST	ASHRAE32
EGZS90HLP	R-134a	115-127 V 60 Hz 1 ~	60 Hz	LBP	1/4+	1,54	239	7,15	IS07	RSCR – 12 μF	LST	ASHRAE32

Embraco/Embraco piston compression emu45hsc detailed parameters:

Refrigerant:	R-134a	Displacement (cm ³):	3.77
Voltage:	220-240V 50-60Hz 1~	Lubricant category:	IS010

frequency(Hz):	50	Lubricating oil volume (ml):	160
application:	LBP	motor model:	RSCR
horsepower:	1/6	Starting torque:	LST
efficiency:	1.40	Test type:	ASHRAE32
Cooling capacity:	109		

Number: 513308034 513308056 513308063

Appearance

	shape	material	Dimensions (mm)
suction port	Slanted	Copper	6.50
exhaust port	Straight	Copper	4.94
Process interface	Straight	Copper	6.50
Oil cooler:			
Floor:	Universal EG/F/AMEM version 2		
bracket:	No		
Weight(kg):	7.74		

application

Maximum ambient temperature (°C):	43
Expansion device:	Capillary
cool down:	Straight cold
Air Velocity:	

mechanical data

Bill of Materials:	513308034
Starting torque:	low starting torque
Bore (mm):	19.00
Stroke(mm):	6.65
Weight(kg):	7.74

digital data

motor model:	RSCR
Wireset Resistance (25°C) – Startup (25°C) – Startup:	19.00
Cordset Resistance (26°C) – Operating (25°C) – Operating:	27.10

Check point – condensing temperature 54.4 °C

Evaporation temperature	Cooling capacity +/-5%			Energy consumption +/-5%	Now energy efficient +/-5%	Energy efficiency +/-7%		
	°C	(kcal/h)	(IN)	(Btu/h)	(IN)	(A)	(kcal/Wh)	(W/W)
-23.3	94	109	372	75	0.36	1.25	1.46	4.98

Condensing temperature 45°C

Evaporation temperature	Cooling capacity +/-5%			Energy consumption +/-5%	Now energy efficient +/-5%	Gas flow rate +/-5%	Energy efficiency +/-7%		
	°C	(kcal/h)	(IN)	(Btu/h)	(IN)	(A)	(kg/h)	(kcal/Wh)	(W/W)
-35	49	56	193	57	0.28	1.09	0.85	0.99	3.38
-30	74	86	293	64	0.30	1.66	1.16	1.35	4.60
-25	98	114	390	71	0.34	2.21	1.39	1.61	5.50
-20	125	145	496	79	0.38	2.82	1.59	1.84	6.29
-15	157	183	623	87	0.42	3.56	1.80	2.09	7.13
-10	197	229	783	97	0.47	4.49	2.04	2.37	8.10

Condensing temperature 55°C

Evaporation temperature	Cooling capacity +/-5%			Energy consumption +/-5%	Now energy efficient +/-5%	Gas flow rate +/-5%	Energy efficiency +/-7%		
	°C	(kcal/h)	(IN)	(Btu/h)	(IN)	(A)	(kg/h)	(kcal/Wh)	(W/W)
-35	39	45	154	55	0.25	0.87	0.70	0.81	2.77
-30	62	72	247	63	0.29	1.40	0.99	1.15	3.92
-25	85	99	337	72	0.34	1.91	1.18	1.38	4.70
-20	110	127	435	81	0.39	2.47	1.35	1.57	5.35
-15	139	162	552	92	0.45	3.15	1.52	1.77	6.03
-10	177	206	702	103	0.50	4.02	1.72	2.00	6.82

Condensing temperature 65°C

Evaporation temperature	Cooling capacity +/-5%			Energy consumption +/-5%	Now energy efficient +/-5%	Gas flow rate +/-5%	Energy efficiency +/-7%		
	°C	(kcal/h)	(IN)	(Btu/h)	(IN)	(A)	(kg/h)	(kcal/Wh)	(W/W)
-35	29	33	114	56	0.29	0.65	0.51	0.59	2.03
-30	51	60	204	64	0.33	1.15	0.80	0.93	3.16
-25	73	84	288	74	0.37	1.64	0.99	1.15	3.91
-20	96	111	380	84	0.41	2.16	1.14	1.32	4.52
-15	124	144	491	96	0.45	2.80	1.29	1.50	5.12
-10	159	185	632	109	0.48	3.62	1.47	1.71	5.82

Embraco/Embraco Piston Compression Product List:

model	Refrigerant	Voltage	frequency	application	horsepower	frequency/rotation	Cooling capacity	Displacement(cm ³)	Lubricant category	motor model	starting torque	test type
EM2U80HLP	R-134a	115-127V 60Hz 1~	60Hz	LBP	1/4	1.70	232	6.76	IS010	RSCR-12μF	LST	ASHRAE32
EM2U80HLP	R-134a	115-127V 60Hz 1~	60Hz	LBP	1/4	1.70	232	6.76	IS010	RSCR-15μF	LST	ASHRAE32
EM2U80HLP	R-134a	115-127V 60Hz 1~	60Hz	LBP	1/4	1.65	232	6.76	IS010	RSIR	LST	ASHRAE32
EM2U80HLP	R-134a	220V 60Hz 1~	60Hz	LBP	1/4	1.67	232	6.76	IS010	RSCR-4μF	LST	ASHRAE32
EM2U80HLP	R-134a	220V 60Hz 1~	60Hz	LBP	1/4	1.61	232	6.76	IS010	RSIR	LST	ASHRAE32
EM2Z80HLT	R-134a	115-127V 60Hz 1~	60Hz	LBP	1.76	239	6.76	IS010	RSCR-12μF	LST	ASHRAE32	
EM2Z80HLT	R-134a	115-127V 60Hz 1~	60Hz	LBP	1.76	239	6.76	IS010	RSCR-15μF	LST	ASHRAE32	
EM20HHR	R-134a	220-240V 50-60Hz 1~	50Hz	HBP	1/12	2.51	246	2.27	IS022	RSIR-CSIR	LST	CECOMAF
EM20HBR	R-134a	115V 60Hz 1~	60Hz	HBP	1/12	2.37	289	2.27	IS022	RSIR	LST	ASHRAE32
EM20HHR	R-134a	220-240V 50-60Hz 1~	60Hz	HBP	1/12	2.48	292	2.27	IS022	RSIR-CSIR	LST	ASHRAE32
EM20HHR	R-134a	115-127V 60Hz 1~	60Hz	HBP	1/12	2.53	299	2.27	IS022	RSIR-CSIR	LST	ASHRAE32
EMIS20HHR	R-134a	115-127V 60Hz 1~	60Hz	HBP	1/12	2.49	308	2.27	IS022	RSIR-CSIR	LST	ASHRAE32
EMIS20HHR	R-134a	220V 60Hz 1~	60Hz	HBP	1/12	2.37	308	2.27	IS022	RSIR-CSIR	LST	ASHRAE32



Mbsm_dot_pro_private_PDF_emu45hsc

**Mbsm.pro, Compressor, Zanussi
,ZEL, 0F1033A, 1/5 hp, 1bp,
220-240V, 50HZ, R134A**

written by rober us | 31 March 2023



C 8665853

Electrolux
COMPRESSORS
OF1033C 0225
200--220V~50Hz
R134a
8 054
0916710 2

Mbsm.pro, Compressor, Zanussi , ZEL, 0F1033A, 1/5 hp, 1bp, 220-240V, 50HZ, R134A

- Voltage frequency
220-240V/50Hz
- Refrigerant / Réfrigérant
R134a
- Nominal horsepower / Horse Power
1/5CV
- Application condition/ Application
PSL
- Cooling capacity (w) Capacité de refroidissement
50-70
- Type of engine
RSIR
- La temperature d'évaporation (W)
-23.3°C



◎ R134a LBP 220-240V/50Hz

系列 规格系列	型号	排气 温度	排气 压力	排气 速度	制冷量 (W) 蒸发温度 (°C) / Cooling Capacity ASHRAE											最大 功率 kW	能效 比 EER	高度 mm	
					W / °C														
					-30	-25	-23.3	-20	-15	-10	-5	0	5	7.2	10				
T系列 规格系列 LBP	CF605	3.4	U11	RSR	45	59	76	95	119	149	185	228					70	0.98	163
	CF790	3.8	1B-	RSR	55	72	94	118	147	184	229	292					85	1.01	163
	CF789	4.4	1B	RSR	65	85	110	138	172	216	268	330					102	1.03	174
	DF103A	5.7	1B-	RSR	83	109	141	176	220	276	344	423					118	1.18	174
	DF130A	7.5	1A-	RSR	108	137	178	223	278	349	434	534					158	1.13	183
	GVY3AA	3.5	U11	RSRRSQR	47	62	80	100	125	157	195	240					99	1.16	163
T系列 规格系列 LBP	GVY4AA	4.2	1T	RSRRSQR	59	77	100	125	158	198	244	300					83	1.20	174
	GVY4AA	4.4	1B	RSRRSQR	70	91	118	145	184	231	288	354					94	1.25	174
	GVY3AA	5.3	1B-	RSRRSQR	82	107	139	174	217	272	339	417					105	1.33	174
	GVY3AA	5.7	1B-	RSRRSQR	89	116	150	188	234	294	366	450					113	1.33	174
	GVY6AA	6.6	1B+	RSRRSQR	107	140	182	228	284	357	444	540					133	1.37	174
	GVY7AA	7.5	1B+	RSRRSQR	118	154	200	250	312	382	465	560					149	1.34	174
高压机 规格系列 LBP	GTW6AA	6.6	1A	RSRRSQR	136	172	220	280	350	431	521	630					161	1.43	174
	GTW6AA	8.3	1A	RSRRSQR	163	209	267	335	426	519	634	760					182	1.43	184
	GTW6AA	8.3	1A	RSR	180	236	298	370	471	579	699	819					220	1.38	184
	GTW15AA	10.0	1C	CSR	177	231	306	375	468	588	720	860					222	1.38	184
	GTW15AA	12.0	1C	CSR	199	264	338	413	518	647	800	960					243	1.37	184

Private Picture Copyright : WWW.MBSM.PRO

◎ R134a LBP 220-240V/50Hz

系列 规格系列 LBP	型号	排气 温度	排气 压力	排气 速度	制冷量 (W) 蒸发温度 (°C) / Cooling Capacity ASHRAE											最大 功率 kW	能效 比 EER	高度 mm		
					W / °C															
					-30	-25	-23.3	-20	-15	-10	-5	0	5	7.2	10					
Lambda 规格系列 LBP	GL20A	3.4	U12	RSR	40	53	68	85	106	133	166	204					87	1.20	162	
	GL11A	4.1	1B	RSR	55	72	91	112	140	175	220	273	336					90	1.25	162
	GL14A	4.9	1B	RSR	65	86	108	133	160	195	238	292	350					108	1.30	162
	GL140A	4.9	1B	RSRRSQR	83	108	140	175	218	274	340	420					108	1.40	172	
	GL180A	5.7	1B	RSRRSQR	99	129	168	210	262	329	410	504					125	1.30	180	
	GL180A	6.6	1B	RSRRSQR	110	144	187	234	290	367	456	561					141	1.30	184	
高压机 规格系列 LBP	GL200A	7.5	1B	RSRRSQR	118	154	200	250	312	382	465	560					152	1.32	184	
	GL190A	8.7	1T	RSR	104	136	176	220	275	343	420	528					1	1.64	184	
	GL200A	7.5	1B	RSR	126	164	213	266	332	417	510	630					1	1.64	184	

◎ R134a MHPB 220-240V/50Hz

系列 规格系列 MHPB	型号	排气 温度	排气 压力	排气 速度	制冷量 (W) 蒸发温度 (°C) / Cooling Capacity ASHRAE											最大 功率 kW	能效 比 EER	高度 mm
					W / °C													
					-30	-25	-23.3	-20	-15	-10	-5	0	5	7.2	10			
高压机 规格系列 MHPB	GL80T	5.3	1B	CSR				172	213	260	320	410	503	540	605	340	2.25	174
	GL80T	7.5	1B	CSR				204	252	308	380	486	595	640	717	352	2.44	184
	GL80T	7.5	1B	CSR				239	296	361	456	570	698	750	840	321	2.32	184
	GL10T	8.3	1B	CSR				248	307	378	476	593	725	780	874	342	2.28	184
	GL10T	8.3	1B	CSR				281	347	423	537	669	819	880	995	479	2.05	184
	GHP13AA	13.0	1	CSR				351	433	529	671	836	1020	1100	1230	350	2.00	215
高压机 规格系列 MHPB	GHP15AA	15.0	1	CSR				415	512	625	783	988	1200	1300	1456	350	2.00	215
	GHP15AA	18.0	1	CSR				510	630	770	976	1216	1488	1600	1780	330	2.20	215
	GHP21AA	21.0	1	CSR				606	749	914	1156	1444	1767	1900	2128	300	2.10	215

Private Picture Copyright : WWW.MBSM.PRO

Mbsm.pro, Compressor, embraco, aspera, egas80h1r, 1/4 hp++, 1/3 hp-, R134A, 195W

written by rober us | 31 March 2023



Compresseur hermétique Embraco EGAS80HLR – HMBP – R134a

220-240/1/50 – CSIR Volume balayé : 6.36 cm³

Mbsm_dot_pro_private_PDF___egas80h1r

Mbsm_dot_pro_private_PDF__egas80h1r

Mbsm_dot_pro_private_PDF__egas80h1r

Mbsm_dot_pro_private_PDF_egas80h1r



Mbsm.pro, **Compressor,**
aza2370y, 1/6 **hp, r134a,**
Kulthorn

written by rober us | 31 March 2023



KULTHORN Thermally Protected
AZ A2370Y S88
 220 - 240 V ~ 50Hz R134a CE
 RLA 0.9 LRA 5

 S8824C18000340 RoHS
 KULTHORN KIRBY
 MADE IN THAILAND

คำเตือน WARNING 注意事项
 1. ตัดวงจรไฟฟ้าทุกครั้งก่อนเปิดฝา
 DISCONNECT POWER BEFORE REMOVING COVER
 开盖之前必须关闭电源
 2. การทดสอบแรงดันภายในตัวคอมเพรสเซอร์ต้องไม่เกิน 1000 kPa (150 psig)
 TEST PRESSURE MUST NOT EXCEED 1000 kPa (150 psig)
 气压试验不得超过 1000 kPa (150 psig)
 3. คอมเพรสเซอร์ต้องต่อสายดิน
 THIS COMPRESSOR MUST BE GROUNDED
 压缩机应连接地下线
 --- การละเลยอาจเป็นอันตรายถึงชีวิต ---
 NEGLIGENCE MAY RESULT IN SERIOUS INJURY OR DEATH
 否则有生命危险

Private Picture Copyright : WWW.MBSM.PRO

Mbsm.pro, Compressor, aza2370y, 1/6 hp, r134a, Kulthorn

 Mbsm_dot_pro_private_PDF__aza2370y 
Mbsm_dot_pro_private_PDF_aza2370y

Mbsm.pro, Copeland, Scroll Compressor, série ZB, CR37K6M PFZ-101, 3 hp, r22

written by rober us | 31 March 2023

 **Copeland Scroll Compressor série ZB – Modèle CR37K6M PFZ-101**



Puissance (HP): 3,08

Ampères de charge nominaux (RLA) : 16

Ampères à rotor bloqué (LRA) : 90

Réfrigérant : R22

Alimentation électrique : 220-240V/1P/50Hz

 Mbsm_dot_pro_private_PDF__Cr37k6m 
Mbsm_dot_pro_private_PDF_Cr37k6m

Mbsm.pro, LS19GBBDI, LG

Refrigerator, 17.9 Cu.Ft , Silver PCM Color, Smart Inverter, Domper Compressor, vfl110cy1, 1/4 hp, r600a

written by rober us | 31 March 2023

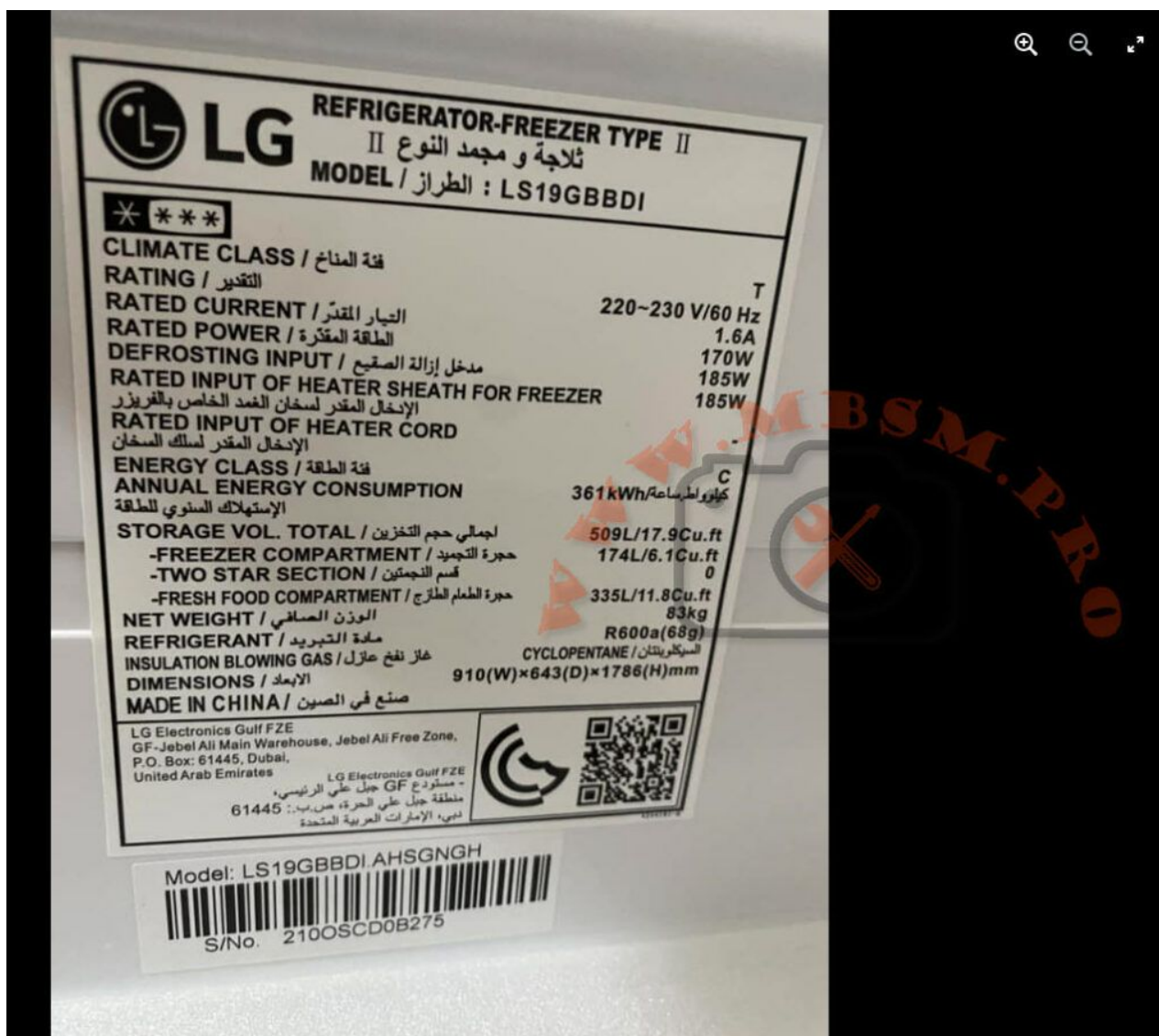

Private Picture Copyright : WWW.MBSM.PRO



Type	frequency conversion	Model	VFL110CY1
Refrigerant	R600a	Voltage	

Frequency□		Application□	LBP
HP□		Displacement(cm ³)□	11
Cooling□	ST	Lubricant Type□	
Lubricant(ml)□		Motor Type□	BLDC
Starting Type□		Starter□	