

Compressor, ZMC, EGM99AZ, 1/4 Hp, 1PH, R134a, LBP, 220-240V 50Hz

written by Lilianne | 29 December 2020



Private Picture Copyright: WWW.MBSM.PRO

General Data

R134a	:Refrigerant
LBP	:Application
30°C to -10°C-	:Evaporating Temperature Range
220/240V/50 HZ	:Voltage/Frequency
Static	:Compressor Cooling
Capillary Tube	:Expansion Device
Multi - 96:120 pcs	:Packaging Quantity
CE-VDE-GOST	:Approvals



Private Picture Copyright : WWW.MBSM.PRO



Circuit Diagram for Mod.90 Terminal Board

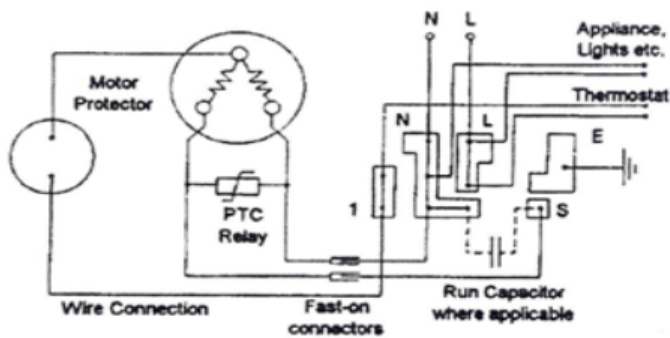

Circuit Diagram for U.H. Terminal Board

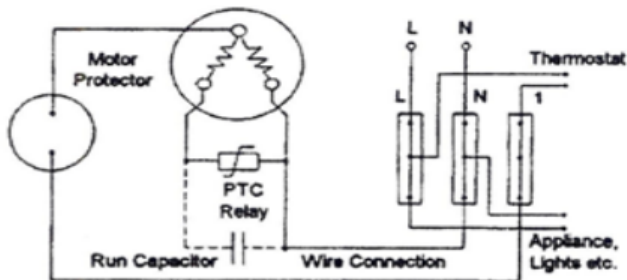

Private Picture Copyright : WWW.MBSM.PRO

PERFORMANCE CURVE DATA :

EGM99AZ

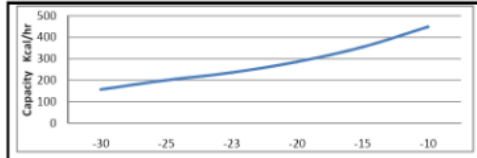

Capacity - Kcal/hr	157	200	236	286	355	449
Evap. Temp. (°C)	-30	-25	-23.3	-20	-15	-10

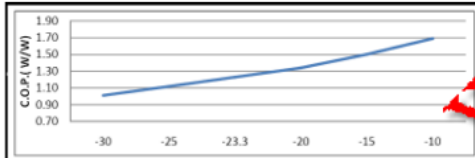

C.O.P. W/W	1.01	1.12	1.23	1.34	1.50	1.69
Evap. Temp. (°C)	-30	-25	-23.3	-20	-15	-10

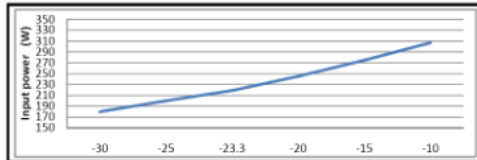

Input power (W)	180	200	219	245	275	307
Evap. Temp. (°C)	-30	-25	-23.3	-20	-15	-10

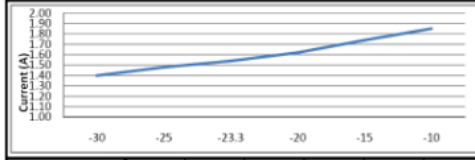

Current (A)	1.40	1.48	1.54	1.62	1.74	1.85
Evap. Temp. (°C)	-30	-25	-23.3	-20	-15	-10

Test Condition: Ashrae, Static, Return Gas 32°C Subcooling OK, Evaporating: 23.3°C, Condensing: 55°C, Ambient: 32°C



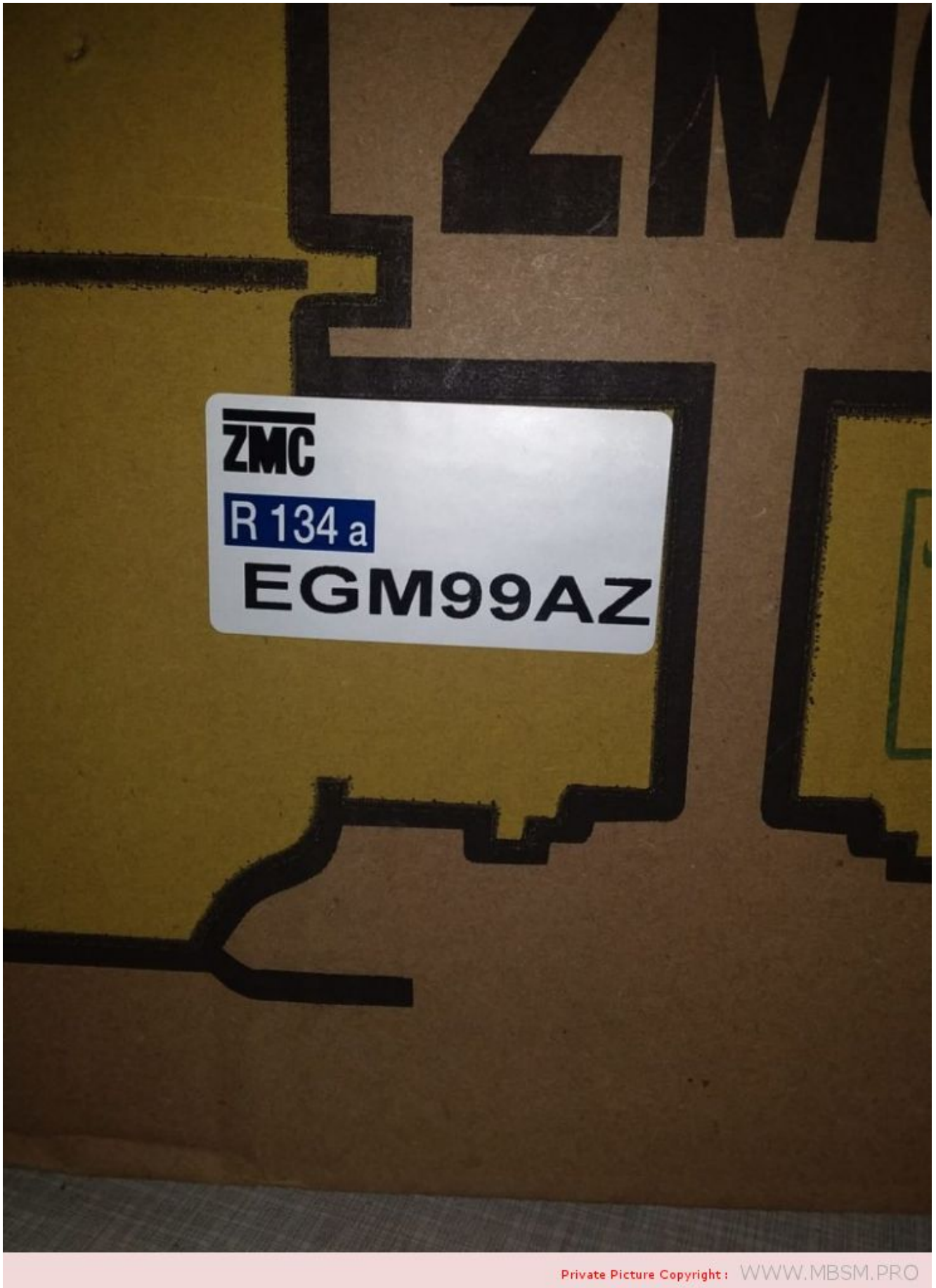

Private Picture Copyright : WWW.MBSM.PRO

Mbsm_dot_pro_private_PDF_EGM99AZTélécharger

Compresseur, Secop, GTK80AT, 232W, R134, LBP, 1/4 HP, RSIR, 791 BTU

written by Lilianne | 29 December 2020

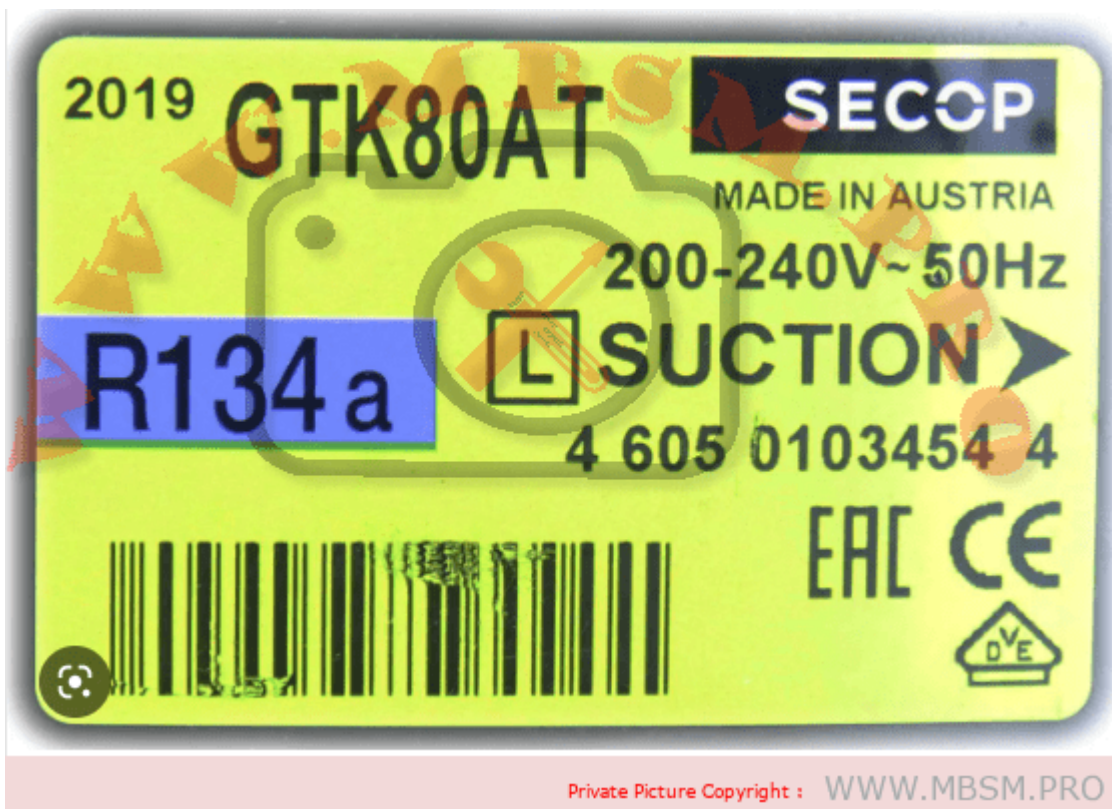















Le compresseur Secop hermétique GTK80AT RSIR est silencieux et dispose d'une large gamme de fonctionnalités utiles. Convient pour une utilisation dans les systèmes de réfrigération domestiques et industriels. Il a une taille compacte et des performances élevées, une faible consommation d'énergie et une haute qualité. Adapté aux chutes de tension et résiste à de fortes charges.

Caractéristiques du compresseur Secop GTK80AT

- Fiabilité combinée à une longue durée de vie
- Faible niveau de bruit
- Protection thermique interne du moteur
- Tubes d'acier
- Ressort sur tube à décharge interne



Compresseur	Réfrigération Q, W	Rendez-vous	Source de courant	Coût, frotter	Disponibilité
 cubigel GL99AAb R134a (LBP)	237	Basse température	1 phase / 220 V / 50 Hz	n / a	0 pièces
 cubigel GL90AAa R134a (LBP)	223	Basse température	1 phase / 220 V / 50 Hz	4 324,52	5 pièces et plus
 cubigel GL90AAb R134a (LBP)	223	Basse température	1 phase / 220 V / 50 Hz	n / a	0 pièces
 cubigel GL90ANa	221	Basse température	1 phase / 220 V / 50 Hz	n / a	0 pièces
 cubigel GL90ANb	221	Basse température	1 phase / 220 V / 50 Hz	n / a	0 pièces
 cubigel GL90ANc	221	Basse température	1 phase / 220 V / 50 Hz	n / a	0 pièces
 cubigel GL99AAa R134a (LBP)	237	Basse température	1 phase / 220 V / 50 Hz	4 384,85	5 pièces et plus
 cubigel GLY80AAa	221	Basse température	1 phase / 220 V / 50 Hz	n / a	0 pièces
 cubigel GLY80AAb	221	Basse température	1 phase / 220 V / 50 Hz	n / a	0 pièces
 cubigel HYE81Ya	235	Basse température	1 phase / 220 V / 50 Hz	3 021,23	5 pièces et plus
 embraco NEK1118Z R-134a / LBP / 8,39 cm3	224	Basse température	1 phase / 220 V / 50 Hz	5 917,97	5 pièces et plus
 embraco NEK2117GK	235	Basse température	1 phase / 220 V / 50 Hz	n / a	0 pièces
 SECOP NL9F	212	Basse température	1 phase / 220 V / 50 Hz	n / a	0 pièces
 SECOP NL9FT (LBP)	220	Basse température	1 phase / 220 V / 50 Hz	5 950,37	5 pièces et plus
 SECOP GTK80AT (R134a)	232	Basse température	1 phase / 220 V / 50 Hz	3 650,38	5 pièces et plus
 Tecmatec AE2410Y_FZ1A R134a	240	Basse température	1 phase / 220 V / 50 Hz	n / a	0 pièces
 Tecmatec AE1390Y_FZ1A	214	Basse température	1 phase / 220 V / 50 Hz	n / a	0 pièces



Model

Designation **GTK80AT** 200-240V/50Hz 1~

Sales code: **CDO00155**

Compressor design

Oil type	Polyolester	Refrigerant(s)	R134a
Oil viscosity	15cSt	Displacement	7,7cm ³ / 0,47cu.in
Oil quantity	156cm ³ / 5,3fl.oz	Compressors on pallet	100
Refr. charge - tech. limit			
Free gas volume comp.	1560cm ³ / 52,7fl.oz		
Weight	9,1kg / 20,1lbs		
Motor protection	external		
Winding resistance main	10,4Ω (at 25°C)		
Winding resistance aux	20,5Ω (at 25°C)		
Max. winding temp.	130°C / 266°F		
Max. discharge temp.	130°C / 266°F		

**General - Configurations with GTK80AT**

	Conf. 1	Conf. 2
Motorconfiguration	RSCR	RSIR
Power supply (nominal)	200-240V/50Hz	200-240V/50Hz
Number of phases	1	1
Voltage range	170-264V	170-264V
Approvals	VDE, EAC	VDE, EAC
Starting torque	LST	LST
Note	- / -	

Applications with GTK80AT

	Conf. 1	Conf. 2
Refrigerant	R134a	R134a
Application	LBP	LBP
System cooling	static	static
Hot gas defrost	- / -	- / -
Long interval pull down	- / -	- / -

Electrical data - Configurations with GTK80AT

	Conf. 1	Conf. 2
Starting device type	PTC	PTC
Run capacitor	4μF	- / -
Start capacitor	- / -	- / -
LRA (locked rotor amps / 4s)	8,25A	8,25A
RLA (rated load amps / 1s)		
Cut in current	15,5A	15,5A
IP class	21	21

ООО «Промхолд-Ровно»
 (098) 111-73-73
 (099) 111-61-63
 (063) 111-64-63

Model

Designation **GTK80AT 200-240V/50Hz** Conf. 1 Sales code: **CDO00155**

Optimization + standard conditions

200V/50Hz, RSCR, static, VDE, EAC

	Evaporating pressure (saturation temperature)				Condensing pressure (saturation temperature)			Return gas temp.		Liquid temp.		Cooling capacity			COP	EER	Power consumption		Ref. mass flow ṁ	
	pe	pc	RGT	Tliq	[W]	[Btu/h]	[kcal/h]	[W/W]	[Btu/Wh]	[kcal/Wh]	P1	I	[kg/h]							
[°C]	-23,3	54,4	32,2	32,2	231,5	791	199,2	1,60	5,46	1,38	144,8	0,66	4,49	ASHRAE LBP						
[°F]	-10	130	90	90																
[°C]	-25	55	32	55	170,5	582	146,7	1,23	4,19	1,06	138,8	0,63	4,08	cecomaf LBP						
[°F]	-13	131	89,6	131																
[°C]	-35	40	20	40	121,3	414	104,4	1,16	3,96	1,00	104,7	0,48	2,66	EN12900 LBP						
[°F]	-31	104	68	104																
[°C]	-23,3	48,9	4,44	48,9	190,7	651	164,1	1,35	4,62	1,16	141,1	0,64	5,04	ARI540 LBP						
[°F]	-10	120	40	120																
[°C]	-23,3	40,6	32,2	32,2	253,4	865	218,0	1,87	6,39	1,61	135,4	0,66	4,92	AHAM LBP						
[°F]	-10	105	90	90																
[°C]	-35	45	32	45	112,9	386	97,2	1,06	3,62	0,91	106,4	0,46	2,44	opt						
[°F]	-31	113	89,6	113																

Performance tables

200V/50Hz, RSCR, static, VDE, EAC

	pe	Cooling capacity			COP	EER	P1	I	m		
	[°C]	[°F]	[W]	[Btu/h]	[kcal/h]	[W/W]	[Btu/Wh]	[kcal/Wh]	[W]	[A]	[kg/h]
[°C / °F]	-35	-31	112,9	386	97,2	1,06	3,62	0,91	106,4	0,46	2,44
cond. pressure	-30	-22	154,5	528	133,0	1,31	4,47	1,13	118,2	0,54	3,34
pc= 45/113	-25	-13	203,5	695	175,2	1,53	5,23	1,32	132,8	0,62	4,41
return gas temp.	-23,3	-10	222,2	759	191,2	1,61	5,48	1,38	138,4	0,65	4,82
RGT= 32/90	-20	-4	261,7	894	225,2	1,75	5,97	1,50	149,7	0,71	5,68
liquid temp	-15	5	330,7	1129	284,6	1,97	6,73	1,70	167,8	0,81	7,21
Tliq= 45/113	-10	14	412,5	1409	355,0	2,21	7,55	1,90	186,6	0,90	9,03
[°C / °F]	-35	-31	85,6	292	73,7	0,80	2,73	0,69	107,1	0,45	2,04
cond. pressure	-30	-22	125,3	428	107,8	1,03	3,53	0,89	121,3	0,53	2,99
pc= 55/131	-25	-13	170,5	582	146,7	1,23	4,19	1,06	138,8	0,63	4,08
return gas temp	-23,3	-10	187,4	640	161,3	1,29	4,40	1,11	145,3	0,66	4,48
RGT= 32/90	-20	-4	222,9	761	191,8	1,41	4,80	1,21	158,6	0,73	5,35
liquid temp	-15	5	284,4	971	244,8	1,58	5,39	1,36	180,0	0,84	6,85
Tliq= 55/131	-10	14	356,8	1218	307,1	1,76	6,02	1,52	202,3	0,95	8,63

	Evaporating pressure (saturation temperature)				Condensing pressure (saturation temperature)			COP	EER			Power consumption			ASHRAE LBP
	pe	pc	RGT	Tliq	W	[Btu/h]	[kcal/h]		W/W	[Btu/Wh]	[kcal/Wh]	P1	I	Ref. mass flow	
	[°C]	[°C]	[°C]	[°C]	[W]	[Btu/h]	[kcal/h]	[W/W]	[Btu/Wh]	[kcal/Wh]	[W]	[A]	[kg/h]		
	-23,3	54,4	32,2	32,2	231,5	791	199,2	1,60	5,46	1,38	144,8	0,66	4,49	ASHRAE LBP	
	[°F]	-10	130	90										LBP	
	-25	55	32	55	170,5	582	146,7	1,23	4,19	1,06	138,8	0,63	4,08	cecomaf LBP	
	[°F]	-13	131	89,6										LBP	
	-35	40	20	40	121,3	414	104,4	1,16	3,96	1,00	104,7	0,48	2,66	EN12900 LBP	
	[°F]	-31	104	68										LBP	
	-23,3	48,9	4,44	48,9	190,7	651	164,1	1,35	4,62	1,16	141,1	0,64	5,04	ARI540 LBP	
	[°F]	-10	120	40										LBP	
	-23,3	40,6	32,2	32,2	253,4	865	218,0	1,87	6,39	1,61	135,4	0,66	4,92	AHAM LBP	
	[°F]	-10	105	90										LBP	
	-35	45	32	45	112,9	386	97,2	1,06	3,62	0,91	106,4	0,46	2,44	opt	
	[°F]	-31	113	89,6											

Private Picture Copyright : WWW.MBSM.PRO

Compresseur	Réfrigération Q, W	Rendez-vous	Source de courant	Coût, frotter	Disponibilité
cubigel GL99AAb R134a (LBP)	237	Basse température	1 phase / 220 V / 50 Hz	n / a	0 pièces
cubigel GL90AAa R134a (LBP)	223	Basse température	1 phase / 220 V / 50 Hz	4 324,52	5 pièces et plus
cubigel GL90AAb R134a (LBP)	223	Basse température	1 phase / 220 V / 50 Hz	n / a	0 pièces
cubigel GL90ANa	221	Basse température	1 phase / 220 V / 50 Hz	n / a	0 pièces
cubigel GL90ANb	221	Basse température	1 phase / 220 V / 50 Hz	n / a	0 pièces
cubigel GL90ANc	221	Basse température	1 phase / 220 V / 50 Hz	n / a	0 pièces
cubigel GL99AAa R134a (LBP)	237	Basse température	1 phase / 220 V / 50 Hz	4 384,85	5 pièces et plus
cubigel GLY80AAa	221	Basse température	1 phase / 220 V / 50 Hz	n / a	0 pièces
cubigel GLY80AAb	221	Basse température	1 phase / 220 V / 50 Hz	n / a	0 pièces
cubigel HYE81Ya	235	Basse température	1 phase / 220 V / 50 Hz	3 021,23	5 pièces et plus
embraco NEK1118Z R-134a / LBP / 8,39 cm3	224	Basse température	1 phase / 220 V / 50 Hz	5 917,97	5 pièces et plus
embraco NEK2117GK	235	Basse température	1 phase / 220 V / 50 Hz	n / a	0 pièces
SECOP NL9F	212	Basse température	1 phase / 220 V / 50 Hz	n / a	0 pièces
SECOP NL9FT (LBP)	220	Basse température	1 phase / 220 V / 50 Hz	5 950,37	5 pièces et plus
SECOP GTK80AT (R134a)	232	Basse température	1 phase / 220 V / 50 Hz	3 650,38	5 pièces et plus
Tourneval AE2410Y_FZ1A R134a	240	Basse température	1 phase / 220 V / 50 Hz	n / a	0 pièces
Tourneval AE1390Y_FZ1A	214	Basse température	1 phase / 220 V / 50 Hz	n / a	0 pièces

Private Picture Copyright : WWW.MBSM.PRO



Les compresseurs Secop R134a sont excellents pour un usage domestique. Ils sont utilisés non seulement dans les réfrigérateurs ménagers et les congélateurs conventionnels de

petit volume, mais aussi dans les équipements des mini-magasins où une source autonome de froid est nécessaire, par exemple:

- vitrines réfrigérées;
- royaux;
- armoires pour le refroidissement des produits laitiers et de l'eau.

Caractéristique:

Puissance frigorifique – 232 W

Réfrigérant – R-134

Compresseur Secop GTK80AT

Attributs de base	
Pays du fabricant	L'Autriche
Fabricant	Secop (anciennement ACC)
caractéristiques supplémentaires	
Capacité de refroidissement	231,5
Fréon	R134a
Volume de travail, cm ³	7,7

Caractéristique

Fabricant	Secop (Danfoss)
Marque du compresseur	Secop
Modèle	GTK
Type de compresseur	Piston scellé
But du compresseur	Basse température
Régulation des performances	Non
Alimentation du compresseur	1 phase / 220 V / 50 Hz

Plage de puissance frigorifique (EN 12900), kW	0-1
Puissance frigorifique (ASHRAE), kW	0,232
Hauteur, mm	174
Longueur, mm	215
Largeur, mm	151
Poids net / kg	9,1
Quantité d'huile, l	0,156
Niveau sonore, dBA	60
Tuyau de dérivation d'aspiration, mm	6,5
Tuyau de dérivation de refoulement, mm	5.5
Volume du cylindre, cm ³	7,7
Réfrigérant	R134a

Mbsm_dot_pro_private_PDF_GTK80ATTélécharger

Mbsm_dot_pro_private_PDF_GTK80AT-1Télécharger

Mbsm_dot_pro_private_PDF_GTK80AT-2Télécharger

**EMX66CTC, Embraco,
compresseurs, 183w, 240v / 50
1/4 HP, R600A, hermétiques,
HVAC, + Ptc, Alu, Hotpoint,
Indesit, Whirlpool, LBP,
Cylindrée (cm³)10,61**

written by Lilianne | 29 December 2020

catégorie de produit

Compresseurs de réfrigération et compresseurs de climatisation

Capacité

0,14 kW (0,1840 ch)

Évaluation du réfrigérant

R-600a

EER

1,18

Source d'énergie

230/50/1

Options de réfrigérant

R-600a

Ce produit est compatible avec les modèles suivants : RSZ 3032 V L BSZ 3032 V BAAAAN 10 SBL 2031 V/HA UPS 1721 F/HA UFAAN 400 NF UPS 1721 F J/HA UPS 1721 F J/HA UPS 1722 F J/HA CAA 55 BAAAAN 12 SBL 2030 V/HA IUPS 1722 F J IUPS 1722 F J IUPS 1721 F J EXFL 2010 P FFFL 2010 K EXFL 2010 G SBL 203A V CAA 55 NX BIAAAA 12 NCAA 55 NCAA 55 NX BIAAAA 10 X BIAAAA 10 UIAA 12 F UIAA 22 Y UIAA 12 F R (UK) UIAA 10 F EBYH 20320 V EBL 20311 V EBL 20321 V EBLH 18311 V 03 EBYH 18321 V NCAA 55 (UK) CAA 55 (UK) CAA 55 K (UK) CAA 55 S (UK) UPSY 1721 F J UPSY 1722 F J FZFM 151 G FZFM 151 P FZFM 171 P FZFM 171 G HSZ3022VL HSZ3022VL BIAA 33 F SI Y BIAA 33 F X H Y RFAA52P RFAA52S RFAA52K EBYH 18242 F EBYH 18242 F EBYH 18201 F EBYH 18201 F UIA 12 (EX) UIA 12 S (EX) FFUL 2012 P FFUL 2012 X FFUL 2012 X BIAAAA 12 X HM325NI IN C 325 AA UK STF200WP NCAA 55 S (UK) EBYH 18213 F 03 H 18223 F 03 EBYH 18223 F 03 STF200WG FUFL 2010 P EBLH 18301 V 03 FZFM 171 SB NBIAAAA 10 NRFAA50S NRFAA50P EBMH 17321 NX NCAA 55 K UK CAA 55 NX UK FFFL 2013 P (03) FFFL 2013 P (03) FFFL 2013 X L 2013 X (03) EBY 18211 F BIAAAA 12 UK IUPSY 1722 F J DBIAA 344 F UK UPS 1521.1 RZFM 151 P.1 RZFM 151 G.1 UPS 1521 (TK).1 FFUL 2012 G UIAA 10 (TK).1 UIAA 12 S.1 NUIAA 12.1 UIAA 12 S (UK).1 UIAA 10 S.1 UIAA 12.1 UIAA 12.1 UIAA 10.12 (UK).1 UIAA 10 (UK).1 UIAA 10.1 BCZ L 400 X (BI)/HA HTF200WP HTF200WG UPS 1746.1 T IN C 425 AA UK FFFL 2012 P FFFL 2012 G AFAA 52 P AI AFAA 52 K AI AFAA 52 S AI CAA 55 S NCAA 55 K EBYH 18242 D F YH 18242 D F ECORM 172 P ECOFL 2010 G ECOFL 2010 G ECOFL 2010 P ECOFL 2010 P BIAAAA 12P X NBIAAAA 10P BIAAAA

12P BIAAA 10P X BIAAA 12P UK BIAAA 10P HM325NI AI UPS 1521 F (TK) NEBYH 18242 F UIAA 12 F I X UX UIX UIX IAA 12 F I UPSI 1721 F/HA UPSI 1721 F (TK)/HA UPSI 1722 F J/HA UPSI 1722 J FSFL 2010 P FZFI 171 G FZFI 171 P UPS0 1722 F J UPS0 1721 F J IUPS0 1721 F J et plus.



Private Picture Copyright : WWW.MBSM.PRO

COOLING CAPACITY CECOMAF																	
CONDENSING TEMPERATURE °C	EVAPORATING TEMPERATURE °C						WEIGHT kg	MAX HEIGHT A mm	LRA A	COOLING TYPE	FAN AIR FLOW m ³ /h	OIL		EXP DEVICE	DRAWINGS		MODEL
	-30	-25	-20	-15	-10	-5						CHARGE cm ³	TYPE		EXTERNAL VIEW REFERENCE	WIRING DIAGRAM REFERENCE	
55	36	49	64	82	102	126	7,1	166	2,1	S	-	150	AB 5	C	DWG01	SM01	EMX20CLC
45	44	58	76	96	119	146	7,1	166	-	S	-	150	AB 5	C	DWG01	SM01	EMX26CLC
55	43	59	80	104	133	165	7,1	166	-	S	-	150	AB 5	C	DWG01	SM01	EMX32CLC
45	53	72	96	124	156	192	7,3	166	3,3	S	-	150	AB 5	C	DWG01	SM01	EMX33CLC
55	49	69	92	119	151	189	7,7	171	6,8	S/F	270	150	AB 5	C/V	DWG01	SM00-SM01	EMX3109Y
45	64	86	111	141	176	218	7,7	171	3,4	S	-	150	AB 5	C	DWG01	SM02	EMC40CLT
55	78	107	142	187	233	260	7,1	166	-	S	-	150	AB 2	C	DWG01	SM02	EMC46CLT
45	88	118	154	198	248	300	8	171	11,6	S/F	270	150	AB 5	C/V	DWG01	SM01	EMX3113Y
55	88	119	158	203	256	280	7,6	166	-	S	-	150	AB 5	C	DWG01	SM01	EMX55CLC
45	95	129	169	215	269	310	7,7	166	14,1	S/F	270	150	AB 5	C/V	DWG01	SM01	EMX3115Y
55	-	-	-	-	-	-	7,4	166	6,4	S	-	150	AB 5	C	DWG01	SM01	EMX66CLC
45	87	117	154	197	245	303	7,4	166	6	S	-	150	AB 5	C	DWG01	SM01	EMX70CLC
55	102	135	175	222	277	339	7,7	166	14,1	S/F	270	150	AB 5	C/V	DWG01	SM01	EMX3118Y
45	101	137	178	227	284	348	7,7	171	7,8	S/F	270	150	AB 5	C/V	DWG01	SM00	EMY3118Y
55	122	160	207	261	323	394											
45	103	143	184	233	290	360											
55	123	164	210	263	327	403											
45	-	-	-	-	-	-											
55	-	-	-	-	-	-											
45	-	-	-	-	-	-											
55	-	-	-	-	-	-											

Private Picture Copyright : WWW.MBSM.PRO

MODEL	DISPL. cm ³	HP	VOLTAGE/FREQUENCY	MOTOR TYPE	TORQUE	APPLICATION	RATED POINT - ASHRAE -23.3 °C / 54.4 °C		RATED POINT - CECCIM -25 °C / 55 °C		CONDENSING TEMPERATURE °C	EVAPORATING		
							CAPACITY W	EFFICIENCY W/W	CAPACITY W	EFFICIENCY W/W		-30	-25	-20
EMX20CLC	4,0	1/14	220-240V 50Hz 1 ~	RSCR	LST	LBP	63	1,66	48	1,3	55	36	49	64
											45	44	58	76
EMX26CLC	5,2	1/12	220-240V 50Hz 1 ~	RSCR	LST	LBP	81	1,68	60	1,32	55	43	59	80
											45	53	72	96
EMX32CLC	6,0	1/10	220-240V 50Hz 1 ~	RSCR	LST	LBP	92	1,72	69	1,35	55	49	69	92
											45	64	86	111
EMX3109Y	6,2	1/10	100V 50Hz / 100-127V 60Hz 1 ~	RSIR/RSCR	LST	L/MBP	100	1,68	-	-	55	-	-	-
EMC40CLT	7,2	1/8	220-240V 50Hz 1 ~	RSCR	LST	LBP	117	1,79	87	1,4	55	78	107	142
											45	88	118	154
EMC46CLT	8,0	1/7	220-240V 50Hz 1 ~	RSCR	LST	LBP	133	1,8	98	1,37	55	88	119	158
											45	95	129	169
EMX3113Y	9,0	1/7	100V 50Hz / 100-127V 60Hz 1 ~	RSCR	LST	L/MBP	155	1,75	-	-	55	-	-	-
											45	-	-	-
EMX55CLC	9,0	1/6	220-240V 50Hz 1 ~	RSCR	LST	LBP	156	1,74	117	1,37	55	87	117	154
											45	102	135	175
EMX3115Y	10,6	1/5	100V 50Hz / 100-127V 60Hz 1 ~	RSCR	LST	L/MBP	184	1,67	-	-	55	-	-	-
											45	-	-	-
EMX66CLC	10,6	1/5	220-240V 50Hz 1 ~	RSCR	LST	LBP	183	1,73	137	1,37	55	101	137	178
											45	122	160	207
EMX70CLC	11,1	1/5	220-240V 50Hz 1 ~	RSCR	LST	LBP	191	1,71	143	1,34	55	103	143	184
											45	123	164	210
EMX3118Y	12,2	1/5	100V 50Hz / 100-127V 60Hz 1 ~	RSCR	LST	L/MBP	212	1,66	-	-	55	-	-	-
											45	-	-	-
EMY3118Y	12,2	1/5	220-240V 50Hz 1 ~	RSIR	LST	L/MBP	212	1,49	157	1,16	55	-	-	-
											45	-	-	-
EMY3118Y	12,2	1/5	220-240V 50Hz 1 ~	RSCR	LST	L/MBP	213	1,58	158	1,23	55	-	-	-
											45	-	-	-
EMX3118Y	12,2	1/5	220-240V 50Hz 1 ~	RSCR	LST	L/MBP	214	1,72	159	1,34	55	-	-	-
											45	-	-	-

Private Picture Copyright : WWW.MBSM.PRO

Mbsm_dot_pro_private_PDF_emx66clc-1-embraco-compressors-10-2019Télécharger

Mbsm_dot_pro_private_PDF_emx66clc-2-embraco-compressors-10-2019Télécharger

COMPRESSEUR, RÉFRIGÉRATION, 1/5 HP, ZR57AA, RSCR, Condensateur Run, LBP, 166 W, R134a

written by Lilianne | 29 December 2020

Modèle	ZR57AA (1 / 5HP)

Caractéristiques	
Type de moteur	RSCR (Condensateur Run) LBP
Volt	220 à 240 V, 50 Hz
Capacité de refroidissement	166 W
FLIC	1,48
La puissance d'entrée	112 W
Courant évalué	0,62 ampères
Réfrigérant	R134a



Private Picture Copyright : WWW.MBSM.PRO



Private Picture Copyright: WWW.MBSM.PRO



Private Picture Copyright: WWW.MBSM.PRO



Private Picture Copyright : WWW.MBSM.PRO



Mbsm_dot_pro_private_PDF_ZR57AATélécharger



**COMPRESSEURS, 1/6, RSIR/RSCR,
124W, CUBIGEL / ACC, TUBED,
R600A, 1PH, HPKD190A,
COMPRESSOR – HPKD190A, R600A,**

Compresseur Zel

written by Lilianne | 29 December 2020



HPKD190A

Congélateur, glacière, 180 à 280 litres, Compresseur LG MA57, 130 W, 1/6Hp, LBP, R134, 220-240V

written by Lilianne | 29 December 2020

Application Réfrigérateur FF	MA57LBJG, MA57LHJG
Capacité	280 litres
Application Congélateur profond	MA57LBJG, MA57LHJG
Capacité	250 litres
Déplacement	5,7
Capacité de refroidissement	138 (kcal / h), 160 W, 548 (Btu / h), 0,215 HP
La puissance d'entrée	130 W
COP W / W	1.2
EER Btu / Wh	4,21
Type de moteur	RSIR-PTC
Dispositif de démarrage (PTC)	QP2-33MC1
Protecteur de moteur (OLP)	4TM232TFB

(Condensateur) Runnig / surtension	4uF / 400
(HUILE) Viscosité cst / Qté (cc)	22/220
Type de refroidissement	ST
Hauteur du compresseur	177 mm
Poids net	9,1 kg.

- Type de compresseur: LBP
- Consommation électrique: 130 W
- Capacité du réfrigérateur: 280 litres.
- Capacité du congélateur: 250 litres.
- Alimentation / fréquence: 220V / 50Hz

Le compresseur de réfrigérateur LG est un mini compresseur d'air courant, qui offre une solution de refroidissement complète pour les réfrigérateurs et les armoires de rangement à usage domestique et professionnel. Les compresseurs d'air LG pour réfrigérateur offrent un fonctionnement compact et silencieux, avec le couple le plus élevé (HST). Ce compresseur d'air garantit une qualité 6s et une fiabilité éprouvée dans le monde entier.

R134a												
Modèle	Application	Tension v	Fréquence hz	PIÈCES ÉLECTRIQUES					PÉTROLE			Type de refroidissement
				Type de moteur	Appareil de démarrage	Condensateur			Viscosité (cst)	Qté (cc)		
						Protecteur de moteur	Départ	Fonctionnement				

NS30LBJG	LBP	220	50	RSIR	P470MC	4TM213SFB			22	180	ST
NS36LBJG				RSIR	P470MC	4TM213SFB			22	180	ST
MA53LAJG				RSIR	P330MC	4TM222VFB			dix	220	ST
MA57LAJG		RSIR	P470MC	4TM213SFB			dix	220	ST		
NS24LADG		220	60	RSIR	P220MC	4TM101RFB			22	180	ST
NS36LADG				RSIR	P220MC	4TM174TFB			22	180	ST
NS36LADG				RSCR	P220MD	4TM174TFB		4/400	22	180	ST
MA53LADG				RSIR	P330MC	4TM232NFB			dix	220	ST
MA53LADM				RSCR	P330MD	4TM232NFB		5/400	dix	220	ST
MA57LADM				RSCR	P330MD	4TM213SFB		5/400	dix	220	ST
NS24LABG		220	50-60	RSIR	P330MC	4TM149NFB			22	180	ST
NS30LABG				RSIR	P220MC	4TM158RFB			22	180	ST
NS36LABG				RSIR	P220MC	4TM174TFB			22	180	ST
MA53LABM				RSCR	P330MD	4TM232NFB		5/400	dix	220	ST
MA57LABM				RSCR	P330MD	4TM213SFB		5/400	dix	220	ST
NS24LAEG		220-240	50	RSIR	P220MC	4TM1175FVB			22	180	ST
NS24LBEG				RSIR	P330MC	4TM1175FVB			22	180	ST
NS30LAEG				RSIR	P330MC	4TM149NFB			22	180	ST
MSA30LAEG				RSIR	P330MC	4TM149NFB			22	180	ST
NS36LAEG				RSIR	P220MC	4TM149NFB			22	180	ST
MSA43LBEG				RSIR	P330MC	4TM166RFB			22	180	ST
MSA43LAEM				RSCR	P330MD	4TM205RFB		4/400	22	180	ST
MA53LAEC				RSIR	P330MC	4TM158RFB			dix	220	ST
MA53LAEM				RSCR	P330MD	4TM232TFB		5/400	dix	220	ST
MSB53LAJG				RSIR	P330MC	4TM213SFB			dix	180	ST
MA57LAEG				RSIR	P330MC	4TM158RFB			dix	220	ST
MA57LAEM				RSCR	P330MD	4TM205RFB		5/400	dix	220	ST
MA57LBEG				RSIR	P330MC	4TM149NFB			dix	200	ST
MC57LAEM				RSCR	P330MD	4TM166RFB		4/400	sept	200	ST
MSB57LAEG				RSIR	P330MC	4TM166RFB			dix	180	ST
MSB57LAEM				RSCR	P330MC	4TM166RFB		4/400	dix	180	ST
MA62LCEG				RSIR	P330MC	4TM232VFB			dix	220	ST
MA62LCEM				RSCR	P330MD	4TM205RFB		5/400	dix	220	ST
MA62LDEG				RSIR	P330MC	4TM232VFB			dix	220	ST
MA69LDEG				RSIR	P330MC	4TM232VFB			dix	220	ST
MA69LCEG				RSIR	P330MC	4TM232VFB			dix	220	ST
MA69LCEM				RSCR	P330MD	4TM232NFB		4/400	dix	220	ST
MA98LAEM				RSCR	P470MD	4TM265RFB		4/400	dix	220	ST
MC98LAEM				RSCR	P470MD	4TM265RFB		5/400	dix	220	ST
MQ98LAEM				RSCR	P470MB	4TM265RFB		5/400	dix	220	ST
MA108LAEH				RSE	P470MB	4TM276VFB	30/300	5/400	dix	220	ST



Private Picture Copyright : WWW.MBSM.PRO

Mbsm_dot_pro_private_PDF_LG_Refrigerator_Compressor_CatalogueT
élécharger

**Compressor, Daewoo,
Hf127Ye-5-k, 134a, RSIR, LBP,
1/3HP, Ye série, 220-240V
50hz, 287 w**

written by Lilianne | 29 December 2020



Mbsm_dot_pro_private_PDF__Hfl27YeTélécharger

Mbsm_dot_pro_private_PDF_Hfl27YeTélécharger

Mbsm_dot_pro_private_PDF_Mbsm_dot_pro_private_PDFdocument-Hfl27YeTélécharger

Mbsm_dot_pro_private_PDF_R134a-LBP-Hfl27YeTélécharger

Mbsm_dot_pro_private_PDFMbsm_dot_pro_private_PDFdocument-Hfl27YeTélécharger

ASPERA, COMPRESSEUR, 1 / 3HP++ (Big), NE6181E, CSIR, HMBP, R22, 220-240V

written by Lilianne | 29 December 2020



NE6181E 1 / 3HP / R22

- ***Détails techniques***

puissance 1/3 CV, cylindrée 7,28 cm³
220 / 240V 50Hz

- LIGNE LIQUIDE (DIAMÈTRE) : 1/4
- LIGNE D'ASPIRATION (DIAMÈTRE) : 5/16

- BRÈVE DESCRIPTION



Mbsm_dot_pro_private_PDF_NE6181ETélécharger

1/5HP, Refrigerator, Samsung, Compressor, R134A, 220-240V, SD162Q-L1UA, PTC-RSCR, 6.16CC

written by Lilianne | 29 December 2020



Model No.: SD162Q-L1UA

Test condition: ASHARE

Evaporating Temperature: -23.3° C

Condensing Temperature: 54.4° C

Displacement: 6.16CC/ Rev

Oil: 180CC

Motor type: PTC-RSCR

Nominal voltage range: 187V~276V at 50Hz

Characteristics:

1. Strong load capacity
2. High efficiency & reliability
3. Reliable starting performance
4. Low noise

v id="StyleTableProd">

Mbsm_dot_pro_private_PDF_qdoc.tips_catalogo-compresores-samsungpdfTélécharger



**R134a, Hitachi,
Compressor, (R012-Series),
FL06s34-tab, FL0739-SQ,
FL0847-SD, FL1152-SB, FL1257-
SR, FL14S62-TAD, FL1568-SQ,
FL20S88-TAC, FL1888-SE,
CL0545-SZ, CL1297-SA, CL1310-
SA, CL1588-DZ, CL1610-DL**

written by Lilianne | 29 December 2020

R134a, Hitachi, Compressor, (R012-Series), FL06s34-tab, FL0739-SQ, FL0847-SD, FL1152-SB, FL1257-SR, FL14S62-TAD, FL1568-SQ, FL20S88-TAC, FL1888-SE, CL0545-SZ, CL1297-SA, CL1310-SA, CL1588-DZ, CL1610-DL

