

**Mbsm.pro, Donper, Hermetic,  
Compressor , R600a, Lj126Cy,  
Lu126cy1, 1/3 Hp, R600a**

written by Lilianne | 16 March 2021



Private Picture Copyright : [WWW.MBSM.PRO](http://WWW.MBSM.PRO)

Mbsm.pro, Donper, Hermetic, Compressor , R600a, Lj126Cy, lu126cy1, 1/3 Hp, R600a

---

**Compressor, Zanussi, HLY80AA,  
1/7Hp, 220-240V 50Hz ~1,  
R600a, ZEM, Low Back  
Pressure, RSIR**

written by Lilianne | 16 March 2021



Private Picture Copyright : [WWW.MBSM.PRO](http://WWW.MBSM.PRO)

Technical Data Sheet  
Compressor model HLY80AAa  
Voltage 220-240V 50Hz ~1  
Refrigerant R600a

## APPLICATION COMPRESSOR MOTOR

Application Low Back Pressure Displacement 8,10 cm<sup>3</sup> Nominal Power 1/7 hp

Refrigerant R600a Diameter 24,29 mm Voltage/Frequency 220-240V 50Hz

Evaporating Temp. -35,0 °C to -10,0 °C Stroke 17,47 mm Voltage range 187-264 V

Expansion Capillar Net Weight 9,45 Kg Type RSIR

Comp. Cooling Static Oil type ISO VG 10 MINER Phase number 1 PH

Max. ambient temp. 43,0 °C Oil charge 205 cm<sup>3</sup> Locked Rotor Amps (LRA) 8,60 A

Max. Cont. Current (MCC) 1,00 A

Main W. resist. at 25°C 22,02 Ω

Start W. resist. at 25°C 22,53 Ω

## NOMINAL PERFORMANCE

### ASHRAE CECOMAF

Cooling Capacity 113 kCal/h 99 W

COP 1,41 W/W 1,11 W/W

EER 1,22 kCal/Wh 0,96 kCal/Wh

Input Power 93 W 89 W

Current 0,62 A 0,60 A

## TEST CYCLE CONDITIONS

### ASHRAE CECOMAF

LBP (B) LBP (A)

Evaporating temp. -23,3 °C -25,0 °C

Condensing temp. 55,0 °C 55,0 °C

Liquid temp. 32,0 °C 55,0 °C

Ambient temp. 32,0 °C 32,0 °C

Suction temp. 32,0 °C 32,0 °C

Voltage/Frequency 220 V 50 Hz 220 V 50 Hz

## ELECTRICAL COMPONENTS

Relay Option 1

Reference PTC K100

Voltage 200-240 V

Resistance 14.00 Ω

Protector Option 1 Option 2 Option 3 Option 4  
Reference MSP318LZ 4TM189NFBYY T0462 AE37FJ  
Current 5,90 A 5,50 A 6,20 A 5,90 A  
Time check 7,5-14 seg 5-15 seg 7,5-14 seg 7,5-14 seg  
Disc temp. (Open/Close) 120,00 / 61,00 °C 120,00 / 61,00 °C  
110,00 / 62,00 °C 115,00 / 62,00 °C

Mbsm\_dot\_pro\_private\_PDF\_HLY80aa\_danfoss\_HLY80AAa\_R600a\_220\_50  
Télécharger







Private Picture Copyright : WWW.MBSM.PRO

smart

---

**ENIEM Refrigerateur, no-frost, Made in Algeria, 540L, 220v-240v/50hz, Inverter, Compressor , Technology , Refrigerator LG, bsa090njmv, Inverter, Small Compressor, 9.8 cc , r600a, 60G, Block dc control inverter**

written by Lilianne | 16 March 2021

ENIEM Refrigerateur, Made in Algeria, 540L, 220v-240v/50hz, Inverter, Compressor , Technology , Refrigerator LG, bsa090njmv, Inverter, Small Compressor, 9.8 cc , r600a, Block dc control inverter





Private Picture Copyright : [WWW.MBSM.PRO](http://WWW.MBSM.PRO)

## Nomenclature

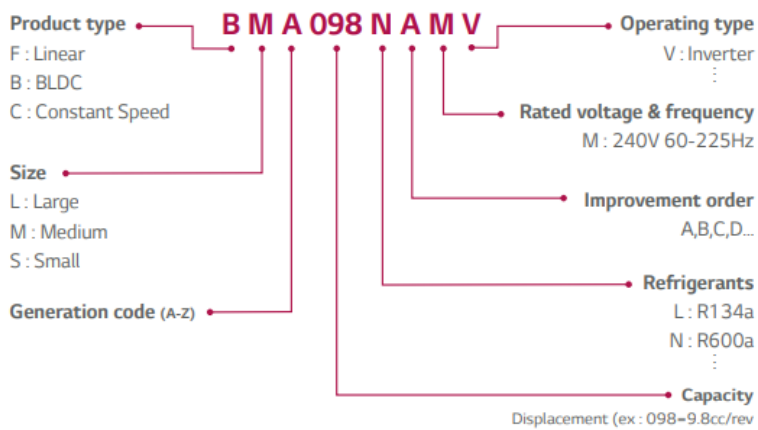

### Wide operating range

- New oil pumping system
- 1,200-4,500rpm

Private Picture Copyright : [WWW.MBSM.PRO](http://WWW.MBSM.PRO)







Private Picture Copyright : [WWW.MBSM.PRO](http://WWW.MBSM.PRO)

Mbsm\_dot\_pro\_private\_PDF\_bsa090njmv -  
Inverter\_Compressor\_Technology\_for\_RefrigeratorReciprocatingTé  
lécharger

**Compresseur hermétique  
Embraco EMX55CLC, LBP, R600a,  
1 / 6Hp, RSCR, Volume balayé  
: 9,04 cm<sup>3</sup>**

written by Lilianne | 16 March 2021

Marque:	EMBRACO
---------	---------

<b>UPC:</b>	3070381
<b>Référence constructeur:</b>	EMX55CLC
<b>Application:</b>	LBP
<b>Source de courant:</b>	220 / 240V 50Hz
<b>Capacité de refroidissement:</b>	154 W
<b>Puissance:</b>	1/6 HP
<b>Déplacement:</b>	9,04 cm <sup>3</sup>
<b>Réfrigérant:</b>	R600a
<b>Poids:</b>	7,85 kg
<b>Type de moteur:</b>	RSCR
<b>Type:</b>	Compresseur à piston hermétique

Compresseur hermétique Embraco EMX55CLC – LBP – R600a  
220-240/1/50 – RSCR Volume balayé : 9,04 cm<sup>3</sup>

## Caractéristiques techniques

- Marque : EMBRACO ASPERA
- Modèle : EMX55CLC
- CYLINDRÉE (CM<sup>3</sup>) 9,04
- FLUIDER-600a
- APPLICATION LBP
- PLAGES D'APPLICATION -35/-10
- PUISSANCE (W) 130
- PUISSANCE FRIGORIFIQUE (TK+40°C) -10/306 -20/192 -30/112  
-35/82
- TENSION (V) 240/1/50
- DÉMARRAGE RSCR
- I.MAX (A) 0,55
- Ø ASPIRATION 6,1
- Ø REFOULEMENT 4,94



Private Picture Copyright : [WWW.MBSM.PRO](http://WWW.MBSM.PRO)

Private Picture Copyright : [WWW.MBSM.PRO](http://WWW.MBSM.PRO)

Mbsm\_dot\_pro\_private\_PDF\_Catalogue\_EmbracoTélécharger  
Mbsm\_dot\_pro\_private\_PDF\_EMX55CLC-datasheetTélécharger



# Compresseur R134a / R600a Série AT / ET (170w-260w) Fiche technique

written by Lilianne | 16 March 2021

**compresseur et110**

[PERPLEXITÉ](#) Voir en détail

Le compresseur **ETA110** est un type de [compresseur de liquide de refroidissement HuaGuang](#) qui utilise le réfrigérant [R600a](#)<sup>[1]</sup><sup>[2]</sup><sup>[3]</sup><sup>[4]</sup><sup>[5]</sup>. Il s'agit d'un compresseur RSIR 1/4HP qui fonctionne à 220-240V et 50Hz avec une faible contre-pression (LBP) de 8kg. Il est couramment utilisé dans les systèmes de réfrigération pour les applications commerciales et industrielles.

[gastroparts](#) [gev-en ligne](#) [n isbets](#) [réfrigérateur-polaire](#) [okmarts](#)

[Afficher la liste](#)

[quel est le prix du compresseur ETA110](#) [+](#)

[où puis-je acheter le compresseur ETA110](#) [+](#)

[Demander un suivi](#) [+](#)

Private Picture Copyright : [WWW.MBSM.PRO](#)

[Fiche technique](#) [Dimensions](#) [Schéma de câblage](#)

Compresseur R134a / R600a Série AT / ET  
(170w-260w)

Compresseur à piston à piston hermétique de type alternatif entraîné par un moteur électrique interne. Eco-friendly conçu sans chlore pour protéger l'ozone. Haute efficacité et économie d'énergie. Démarrage facile Haute fiabilité Faible son et longévité. Avec relais PTC

## compresseur et110

PERPLEXITE

Voir en détail

Le compresseur ET110 est un type de compresseur de liquide de refroidissement HuaGuang qui utilise le réfrigérant R600a. Il s'agit d'un compresseur RSIR 1/4HP qui fonctionne à 220-240V et 50Hz avec une faible contre-pression (LBP) de 8kg. Il est couramment utilisé dans les systèmes de réfrigération pour les applications commerciales et industrielles.



SOURCES

Afficher la liste

1 gastroparts

2 gev-en ligne

3 nisbets

4 réfrigérateur-palais

5 alimarts

RAPPORT

quel est le prix du compresseur ET110

où puis-je acheter le compresseur ET110

Demander un suivi



Private Picture Copyright : WWW.MBSM.PRO



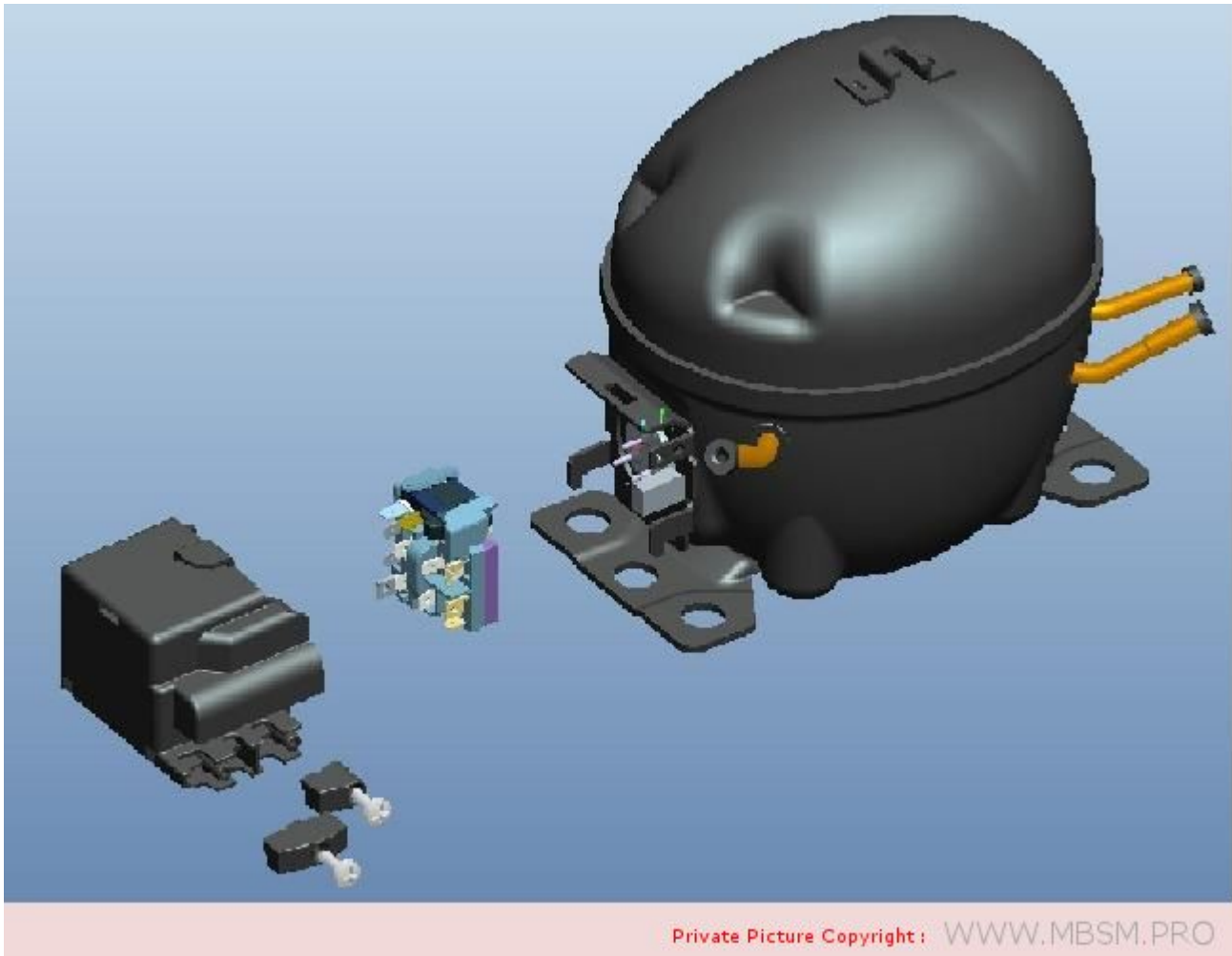

**EMX66CTC, Embraco,  
compresseurs, 183w, 240v / 50  
1/4 HP, R600A, hermétiques,  
HVAC, + Ptc, Alu, Hotpoint,  
Indesit, Whirlpool, LBP,  
Cylindrée (cm<sup>3</sup>)10,61**

written by Lilianne | 16 March 2021

catégorie de produit

Compresseurs de réfrigération et compresseurs de climatisation

Capacité

0,14 kW (0,1840 ch)

Évaluation du réfrigérant

R-600a

EER

1,18

Source d'énergie

230/50/1

Options de réfrigérant

R-600a

**Ce produit est compatible avec les modèles suivants : RSZ 3032 V L BSZ 3032 V BAAAAN 10 SBL 2031 V/HA UPS 1721 F/HA UFAAN 400 NF UPS 1721 F J/HA UPS 1721 F J/HA UPS 1722 F J/HA CAA 55 BAAAAN 12 SBL 2030 V/HA IUPS 1722 F J IUPS 1722 F J IUPS 1721 F J EXFL 2010 P FFFL 2010 K EXFL 2010 G SBL 203A V CAA 55 NX BIAAA 12 NCAA 55 NCAA 55 NX BIAAA 10 X BIAAA 10 UIAA 12 F UIAA 22 Y UIAA 12 F R (UK) UIAA 10 F EBYH 20320 V EBL 20311 V EBL 20321 V EBLH 18311 V 03 EBYH 18321 V NCAA 55 (UK) CAA 55 (UK) CAA 55 K (UK) CAA 55 S (UK) UPSY 1721 F J UPSY 1722 F J FZFM 151 G FZFM 151 P FZFM 171 P FZFM 171 G HSZ3022VL HSZ3022VL BIAA 33 F SI Y BIAA 33 F X H Y RFAA52P RFAA52S RFAA52K EBYH 18242 F EBYH 18242 F EBYH 18201 F EBYH 18201 F UIA 12 (EX) UIA 12 S (EX) FFUL 2012 P FFUL 2012 X FFUL 2012 X BIAAA 12 X HM325NI IN C 325 AA UK STF200WP NCAA 55 S (UK) EBYH 18213 F 03 H 18223 F 03 EBYH 18223 F 03 STF200WG FUFL 2010 P EBLH 18301 V 03 FZFM 171 SB NBIAAA 10 NRFAA50S NRFAA50P EBMH 17321 NX NCAA 55 K UK CAA 55 NX UK FFFL 2013 P (03) FFFL 2013 P (03) FFFL 2013 X L 2013 X (03) EBY 18211 F BIAAA 12 UK IUPSY 1722 F J DBIAA 344 F UK UPS 1521.1 RZFM 151 P.1 RZFM 151 G.1 UPS 1521 (TK).1 FFUL 2012 G UIAA 10 (TK).1 UIAA 12 S.1 NUIAA 12.1 UIAA 12 S (UK).1 UIAA 10 S.1 UIAA 12.1 UIAA 12.1 UIAA 10.12 (UK).1 UIAA 10 (UK).1 UIAA 10.1 BCZ L 400 X (BI)/HA HTF200WP HTF200WG UPS 1746.1 T IN C 425 AA UK FFFL 2012 P FFFL 2012 G AFAA 52 P AI AFAA 52 K AI AFAA 52 S AI CAA 55 S NCAA 55 K EBYH 18242 D F YH 18242 D F ECORM 172 P ECOFL 2010 G ECOFL 2010 G ECOFL 2010 P ECOFL 2010 P BIAAA 12P X NBIAAA 10P BIAAA**



12P BIAAA 10P X BIAAA 12P UK BIAAA 10P HM325NI AI UPS 1521 F (TK) NEBYH 18242 F UIAA 12 F I X UX UIX UIX IAA 12 F I UPSI 1721 F/HA UPSI 1721 F (TK)/HA UPSI 1722 F J/HA UPSI 1722 J FSFL 2010 P FZFI 171 G FZFI 171 P UPS0 1722 F J UPS0 1721 F J IUPS0 1721 F J et plus.



Private Picture Copyright : [WWW.MBSM.PRO](http://WWW.MBSM.PRO)

COOLING CAPACITY CECOMAF																	
CONDENSING TEMPERATURE °C	EVAPORATING TEMPERATURE °C						WEIGHT kg	MAX HEIGHT A mm	LRA A	COOLING TYPE	FAN AIR FLOW m <sup>3</sup> /h	OIL		EXP DEVICE	DRAWINGS		MODEL
	-30	-25	-20	-15	-10	-5						CHARGE cm <sup>3</sup>	TYPE		EXTERNAL VIEW REFERENCE	WIRING DIAGRAM REFERENCE	
55	36	49	64	82	102	126	7,1	166	2,1	S	-	150	AB 5	C	DWG01	SM01	EMX20CLC
45	44	58	76	96	119	146	7,1	166	-	S	-	150	AB 5	C	DWG01	SM01	EMX26CLC
55	43	59	80	104	133	165	7,1	166	-	S	-	150	AB 5	C	DWG01	SM01	EMX32CLC
45	53	72	96	124	156	192	7,3	166	3,3	S	-	150	AB 5	C	DWG01	SM01	EMX33CLC
55	49	69	92	119	151	189	7,7	171	6,8	S/F	270	150	AB 5	C/V	DWG01	SM00-SM01	EMX3109Y
45	64	86	111	141	176	218	7,7	171	3,4	S	-	150	AB 5	C	DWG01	SM02	EMC40CLT
55	78	107	142	187	233	260	7,1	166	-	S	-	150	AB 2	C	DWG01	SM02	EMC46CLT
45	88	118	154	198	248	300	8	171	11,6	S/F	270	150	AB 5	C/V	DWG01	SM01	EMX3113Y
55	88	119	158	203	256	280	7,6	166	-	S	-	150	AB 5	C	DWG01	SM01	EMX55CLC
45	95	129	169	215	269	310	7,7	166	14,1	S/F	270	150	AB 5	C/V	DWG01	SM01	EMX3115Y
55	-	-	-	-	-	-	7,4	166	6,4	S	-	150	AB 5	C	DWG01	SM01	EMX66CLC
45	87	117	154	197	245	303	7,4	166	6	S	-	150	AB 5	C	DWG01	SM01	EMX70CLC
55	102	135	175	222	277	339	7,7	166	14,1	S/F	270	150	AB 5	C/V	DWG01	SM01	EMX3118Y
45	123	164	210	263	327	403	7,7	171	7,8	S/F	270	150	AB 5	C/V	DWG01	SM00	EMY3118Y

Private Picture Copyright : [WWW.MBSM.PRO](http://WWW.MBSM.PRO)

MODEL	DISPL. cm <sup>3</sup>	HP	VOLTAGE/FREQUENCY	MOTOR TYPE	TORQUE	APPLICATION	RATED POINT - ASHRAE -23.3 °C / 54.4 °C		RATED POINT - EURO -25 °C / 55 °C		CONDENSING TEMPERATURE °C	EVAPORATING			
							CAPACITY W	EFFICIENCY W/W	CAPACITY W	EFFICIENCY W/W			-30	-25	-20
EMX20CLC	4,0	1/14	220-240V 50Hz 1 ~	RSCR	LST	LBP	63	1,66	48	1,3	55	36	49	64	
											45	44	58	76	
EMX26CLC	5,2	1/12	220-240V 50Hz 1 ~	RSCR	LST	LBP	81	1,68	60	1,32	55	43	59	80	
											45	53	72	96	
EMX32CLC	6,0	1/10	220-240V 50Hz 1 ~	RSCR	LST	LBP	92	1,72	69	1,35	55	49	69	92	
											45	64	86	111	
EMX3109Y	6,2	1/10	100V 50Hz / 100-127V 60Hz 1 ~	RSIR/RSCR	LST	L/MBP	100	1,68	-	-	55	-	-	-	
											45	-	-	-	
EMC40CLT	7,2	1/8	220-240V 50Hz 1 ~	RSCR	LST	LBP	117	1,79	87	1,4	55	78	107	142	
											45	88	118	154	
EMC46CLT	8,0	1/7	220-240V 50Hz 1 ~	RSCR	LST	LBP	133	1,8	98	1,37	55	88	119	158	
											45	95	129	169	
EMX3113Y	9,0	1/7	100V 50Hz / 100-127V 60Hz 1 ~	RSCR	LST	L/MBP	155	1,75	-	-	55	-	-	-	
											45	-	-	-	
EMX55CLC	9,0	1/6	220-240V 50Hz 1 ~	RSCR	LST	LBP	156	1,74	117	1,37	55	87	117	154	
											45	102	135	175	
EMX3115Y	10,6	1/5	100V 50Hz / 100-127V 60Hz 1 ~	RSCR	LST	L/MBP	184	1,67	-	-	55	-	-	-	
											45	-	-	-	
EMX66CLC	10,6	1/5	220-240V 50Hz 1 ~	RSCR	LST	LBP	183	1,73	137	1,37	55	101	137	178	
											45	122	160	207	
EMX70CLC	11,1	1/5	220-240V 50Hz 1 ~	RSCR	LST	LBP	191	1,71	143	1,34	55	103	143	184	
											45	123	164	210	
EMX3118Y	12,2	1/5	100V 50Hz / 100-127V 60Hz 1 ~	RSCR	LST	L/MBP	212	1,66	-	-	55	-	-	-	
											45	-	-	-	
EMY3118Y	12,2	1/5	220-240V 50Hz 1 ~	RSIR	LST	L/MBP	212	1,49	157	1,16	55	-	-	-	
											45	-	-	-	
EMY3118Y	12,2	1/5	220-240V 50Hz 1 ~	RSCR	LST	L/MBP	213	1,58	158	1,23	55	-	-	-	
											45	-	-	-	
EMX3118Y	12,2	1/5	220-240V 50Hz 1 ~	RSCR	LST	L/MBP	214	1,72	159	1,34	55	-	-	-	
											45	-	-	-	

Private Picture Copyright: [WWW.MBSM.PRO](http://WWW.MBSM.PRO)

Mbsm\_dot\_pro\_private\_PDF\_emx66clc-1-embraco-compressors-10-2019Télécharger

Mbsm\_dot\_pro\_private\_PDF\_emx66clc-2-embraco-compressors-10-2019Télécharger

# COMPRESSEURS, 1/6, RSIR/RSCR, 124W, CUBIGEL / ACC, TUBED, R600A, 1PH, HPKD190A, COMPRESSOR – HPKD190A, R600A, Compresseur Zel

written by Lilianne | 16 March 2021



Variable Speed Range  
变频系列

# R600a

型号	电机	转速范围	排气量	电机类型	制冷量	输入功率	性能系数	高度	重量	认证
Model	Motor	Speed Range	Displ.	Motor Type	Cooling Capacity	Input Power	COP	Height	Net Weight	Certification
		rpm	cm <sup>3</sup>		w	w	w/w	mm	kg	

### 220-240V/50Hz

#### T系列变频 T Series VSC

HKD66FSK	Al	1400-4000	6.6	PMSM	45-150	26-85	Up to 1.90	163	7.1	
HKD75FSK	Al	1400-4000	7.5	PMSM	52-170	29-96	Up to 1.90	163	7.1	
HKD86FSK	Al	1400-4000	8.6	PMSM	60-190	35-105	Up to 1.90	163	7.1	
HKD93FSK	Al	1400-4000	9.3	PMSM	70-210	40-125	Up to 1.90	163	7.1	
HKD10FSK	Al	1400-4000	10.5	PMSM	83-235	49-132	Up to 1.90	163	7.1	CCC
HKD12FSK	Al	1400-4000	11.5	PMSM	95-270	51-154	Up to 1.90	163	7.1	CCC
HKD66FSK I	Cu	1400-4000	6.6	PMSM	45-150	25-82	Up to 1.95	163	8.0	
HKD75FSK I	Cu	1400-4000	7.5	PMSM	52-170	28-93	Up to 1.95	163	8.0	
HKD86FSK I	Cu	1400-4000	8.6	PMSM	60-190	32-102	Up to 1.95	163	8.0	
HKD93FSK I	Cu	1400-4000	9.3	PMSM	70-210	38-115	Up to 1.95	163	8.0	
HKD10FSK I	Cu	1400-4000	10.5	PMSM	83-235	44-123	Up to 1.95	163	8.0	CCC
HKD12FSK I	Cu	1400-4000	11.5	PMSM	95-270	50-146	Up to 1.95	163	8.0	CCC

#### Z系列变频 Z Series VSC

HXZ150FSM	Al	1200-4200	6.5	PMSM	42-150	23-80	Up to 1.90	145	6.9	-
HXZ170FSM	Al	1200-4200	7.0	PMSM	50-170	26-92	Up to 1.90	145	6.9	-
HXZ200FSM	Al	1200-4200	8.6	PMSM	56-200	30-103	Up to 1.90	145	6.9	-
HXZ220FSM	Al	1200-4200	9.2	PMSM	68-220	36-120	Up to 1.90	145	6.9	-
HXZ240FSM	Al	1200-4200	9.5	PMSM	75-240	39-125	Up to 1.90	145	6.9	-
HDZ150FSM	Al	1200-4200	6.5	PMSM	42-150	25-88	Up to 1.80	145	6.3	-
HDZ170FSM	Al	1200-4200	7.0	PMSM	50-170	27-98	Up to 1.80	145	6.3	-
HDZ200FSM	Al	1200-4200	8.6	PMSM	56-200	30-110	Up to 1.80	145	6.3	-
HDZ220FSM	Al	1200-4200	9.2	PMSM	68-220	40-132	Up to 1.80	145	6.3	-
HDZ240FSM	Al	1200-4200	9.5	PMSM	75-240	43-136	Up to 1.80	145	6.3	-

Private Picture Copyright : [WWW.MBSM.PRO](http://WWW.MBSM.PRO)

HPKD190A

**Compresseur Cie., Ltd de Zhejiang Bingfeng, BFM57AA, BFM67AA, BFM80AA, BFM86AA,**

# BFM93AA, BFM10AA , R600A

written by Lilianne | 16 March 2021

## Compresseur Cie., Ltd de Zhejiang Bingfeng

Zhejiang Bingfeng Compressor Co., Ltd s'engage à concevoir et à fabriquer les meilleurs compresseurs de réfrigération.



Private Picture Copyright : [WWW.MBSM.PRO](http://WWW.MBSM.PRO)



Private Picture Copyright : [WWW.MBSM.PRO](http://WWW.MBSM.PRO)



Private Picture Copyright : [WWW.MBSM.PRO](http://WWW.MBSM.PRO)





Private Picture Copyright : [WWW.MBSM.PRO](http://WWW.MBSM.PRO)

- 
- 
- 
- 
- 
- 
- 
- 
- 

---

**refrigerator compressor, LBP,  
1/6Hp, GFF44AA, GFF75AA,  
R134a, 220-240V~50Hz , RSIR,  
130W , 0.65A, Cop: 1.31, Oil**

# charge: 200ml, Compresseurs hermétiques Siberia

written by Lilianne | 16 March 2021



Modèle	Puissance Hp	Déplacement	Capacité de refroidissement	Type de moteur	La puissance d'entrée	Courant évalué	FLIC
GFM44AA	1/6	4,6	120	RSIR	100	0,70	1,20
GFM53AA	1/6 +	5,3	145	RSIR	114	0,88	1,27
GFM57AA	1/5	5,7	165	RSIR	132	0,97	1,25
GFM75AA	1/4 +	7,5	215	RSIR	159	1,20	1,35
GFM10AA	1/3 +	10,0	295	RSIR	220	1,55	1,34
GFM12AA	1 / 2-	12,0	330	RSIR	235	1,85	1,40
GFM12AA_S	1 / 2-	12,0	330	RSIR	235	1,85	1,40

## Série F (F) 220-240V / 50Hz

GFF44 AA	1/6	4,6	130	RSIR / RSCR	99/93	0,65 / 0,53	1,31 / 1,40
GFF57 AA	1/5	5,7	165	RSIR / RSCR	115/110	0,77 / 0,57	1,43 / 1,50
GFF66 AA	1/4	6,6	195	RSIR / RSCR	143/129	0,92 / 0,74	1,36 / 1,51
GFF75 AA	1/4 +	7,5	215	RSIR / RSCR	156/147	1,15 / 0,83	1,38 / 1,46
GFF86 AA	1/3	8,6	250	RSIR / RSCR	179/164	1,24 / 0,90	1,40 / 1,52
GFF93 AA	1/3 +	9,3	270	RSIR / RSCR	185/175	1,25 / 0,95	1,46 / 1,54

## Compresseur haute efficacité série F (T) 220-240V / 50Hz

GFT36A A	1/7	3,6	110	RSCR	68	0,32	1,62
----------	-----	-----	-----	------	----	------	------

GFT44A A	1/6	4.4	130	RSCR	81	0,43	1,60
GFT53A A	1 / 5-	5,3	145	RSCR	96	0,53	1,50
GFT57A A	1/5	5,7	165/168	RSCR	104/98	0,55 / 0,49	1,60 / 1,70
GFT61A A	1/5 +	6.1	182	RSCR	107	0,53	1,70
GFT66A A	1/4	6,6	195	RSCR	115/113	0,58 / 0,55	1,68 / 1,72
GFT75A A	1/4 +	7,5	220	RSCR	129	0,69	1,70
GFT86A A	1/3	8,6	250	RSCR	148	0,73	1,70
GFT93A A	1/3 +	9,3	270	RSCR	166	0,84	1,65

### Série F 115V / 60Hz

GFM44AD	1/6 +	4.6	145	RSIR	111	1,62	1,30
GFM53AD	1/4	5,3	185	RSIR	131	1,75	1,30
GFM57AD	1/4	5,7	195	RSIR	138	1,85	1,30
GFM61AD	1/4 +	6.1	210	RSIR	168/150	2,75 / 1,90	1,25 / 1,40
GFR40AD	1/6	3,6	120	RSCR	84,6	7/8	1,42
GFR57AD	1/4	5,7	195	RSCR	116	1,2 / 7	1,55
GFM93AD	1/4	9,3	305	RSIR	218	3.2	1,40

### Série F 200-220V / 50Hz

GFF53AT	1/6 +	5,3	150	RSCR	106	0,67	1,42
GFF57AT	1/5	5,7	165	RSCR	118	0,86	1,40
GFF66AT	1/4	6,6	196	RSCR	138	1,02	1,42
GFF75AT	1/4 +	7,5	218	RSCR	147	1,07	1,48

GFF86AT	1/3	8,6	250	RSCR	168	1.14	1,49
GFF93AT	1/3 +	9,3	275	RSCR	185	1,23	1,49

**Série F 100V-50 / 60Hz**

GFF66A J	1/4	6,6	195/233	RSCR	135/152	2,15 / 1,95	1,44 / 1,53
GFF93A J	1/3	9,3	270/305	RSCR	190/205	2,95 / 2,58	1,42 / 1,49

**Compresseur série F M / HBP R134a**

**220-240V 50 / 60Hz**

GFL60AG_AL	3/4	5,3	550/650	CSIR	245/265	1,88 / 1,69	2,24 / 2,45
------------	-----	-----	---------	------	---------	----------------	-------------------

**220 à 240 V 50 Hz**

GFL80AA	1	7,5	720	CSIR	317	1,96	2,27
GFL10AA	1.2	9,3	880	CSIR	430	2,50	2.0

**Compresseur série F LBP R600a**

**Série F (M / F) 220-240V / 50Hz**

BFM86A A	1/6 +	8,6	142	RSIR	101	0,82	1,40
BFF86A A	1/6	8,6	142	RSIR / RSCR	93/90	0,65 / 0,51	1,53 / 1,58
BFM93A A	1/5	9,3	155	RSIR	108	0,85	1,43

BFF93A A	1/5	9,3	160	RSIR / RSCR	103/98	0,73 / 0,58	1,55 / 1,63
BFM10A A	1/5 +	10,0	168	RSIR	122	1,01	1,38
BFF11A A	1/4	10,5	185	RSIR	121	0,70	1,45
BFM12A A	1/4 +	12,0	202	RSIR	144	1.10	1,40
BFF12A A	1/4 +	12,0	202	RSIR / RSCR	130/123	1,04 / 0,75	1,55 / 1,64

**Compresseur haute efficacité série F (T) 220-240V / 50Hz**

BFT57A A	1 / 7-	5,7	95	RSCR	53/50	0,28 / 0,24	1,80 / 1,90
BFT75A A	1/6	7,5	130	RSCR	75/72	0,35	1,73 / 1,80
BFT86A A	1/5	8,6	142	RSCR	82/74	0,43 / 0,36	1,73 / 1,92
BFT93A A	1/5	9,3	155	RSCR	82	0,50	1,90
BFT10A A	1/5 +	10,0	175	RSCR	100/92	0,60 / 0,43	1,72 / 1,90
BFT11A A	1/4	10,0	180	RSCR	100	0,54	1,80
BFT12A A	1 / 4-	11,5	200/210	RSCR	116/114	0,54 / 0,52	1,72 / 1,86

**Série F 200-220V / 50Hz**

BFF75AT	1/6	7,5	130	RSCR	80	0,46	1,63
BFF86AT	1/5	8,6	142	RSCR	91,5	0,65	1,55
BFM93AT	1/5	9,3	158	RSIR	112	0,93	1,41
BFF93AT	1/5	9,3	160	RSCR	100	0,66	1,60
BFF11AT	1/4	11	175	RSCR	110	0,76	1,60



BFT12AT	1/4	11,5	200	RSCR	130	1.0	1,50
---------	-----	------	-----	------	-----	-----	------

### Série F 115 / 60Hz

BFR57AD	1/6	5,7	120	RSCR	75	0,73	1,60
BFR75AD	1 / 5-	7,5	156	RSCR	92	0,90	1,70
BFM10AD	2/7	10,0	200	RSCR	133	1,55	1,50
BFR10AD	2/7	10,0	195	RSCR	116	1,32	1,65
BFM12AD	1/3	11,0	230	RSCR	153	1,65	1,50

### Compresseur série F LBP R290a

#### 220 à 240 V / 50 Hz

PFT61AA	3/8	6.1	285	RSCR	183	1,55
PFT66AA	3/8	6,6	310	RSCR	200	1,56
PFT66AA ©	3/8	6,6	310	RSCR	190	1,65
PFT75AA	1 / 2-	7,5	350	RSCR	216	1,62
PFT75AA ©	1 / 2-	7,5	350	RSCR	206	1,70
PFT86AA	1/2	8,6	388	RSCR	258	1,50
PFT86AA ©	1/2	8,6	421	RSCR	263	1,60
PFT93AA ©	3/5	9,3	455	RSCR	284	1,60

### Compresseur série F L / MBP R290

#### 220 à 240 V / 50 Hz

PFL57AA	1/3	5,7	255/490	CSIR	170/235	1,50 / 2,09
---------	-----	-----	---------	------	---------	-------------

PFL75AA	1 / 2-	7,5	350/657	CSIR	248/324	1,41 / 2,03
---------	--------	-----	---------	------	---------	-------------

: GFF44AA	Model: GFF44AA
: 4.4cm	Dispi: 4.4cm
: RSIR/RSCR	Motor Type: RSIR/RSCR
: 130W	Cooling Capacity: 130W
: 99/93W	Input power: 99/93W
: 0.65/0.53A	Rated Current: 0.65/0.53A
: 1.31/1.40	Cop: 1.31/1.40
: 200	Oil Charge: 200



Private Picture Copyright : WWW.MBSM.PRO

## Product Detailed

- 1.pass CB,3C,CE,RoHS
  - 2.excellent start performance
  - 3.strong ability of cooled ambient
  - 4.low noise,low power consumption
- R134a Fluorine-free Freezing Compressor LBP

Model	Displ. (cm3)	Power HP	Motor Type	Volt.- Frequency	Cooling Capacity	Input Power	Rated Current (A)	COP(W/W)	Oil Charge Volume
GFF44AA	4.4	1/6	RSIR/RSCR	220-240V~50HZ	130	99/93	0.65/0.53	1.31/1.40	200
GFF57AA	5.7	1/5	RSIR/RSCR	220-240V~50HZ	166	122/112	0.86/0.62	1.36/1.48	200
GFF66AA	6.6	1/4	RSIR/RSCR	220-240V~50HZ	195	143/132	0.92/0.74	1.36/1.48	200
GFF75AA	7.5	+1/4	RSIR/RSCR	220-240V~50HZ	215	156/147	1.15/0.83	1.38/1.46	200
GFF86AA	8.6	1/3	RSIR/RSCR	220-240V~50HZ	250	156/148	1.24/0.90	1.40/1.52	200
GFF93AA	9.3	1/3	RSIR/RSCR	220-240V~50HZ	270	156/149	1.25/0.95	1.46/1.54	230

### Test Conditions(ASHRAE)

Evaporating temperature -23.3°C

Condensing temperature 54.4°C

Subcooling temperature 32.2°C

Suction temperature 32.2°C

Ambient temperature 32.2°C

About Advantages of Model GFF44AA, 1/6HP

- 1.high efficiency, energy-saving
- 2.R134a fluorine-free compressor
- 3.adjustable low-carbon emission
- 4.excellent cooling speed, large capacity

About More Application of Model GFF44AA

1.fit for small ice machine(maker)

2.suitable for home fridge or freezer

3.ice cream display, showcase, wine display, and other freezing equipments

#### About Compressor Spare Parts

1. four rubber sleeve
2. one PTC starter
3. one capacitor
4. one relay cover
5. one overload protector
6. four shockproof rubber washer



Private Picture Copyright : [WWW.MBSM.PRO](http://WWW.MBSM.PRO)

- GTM 45 AA 1/6 130 watts R 134 A
- GFF 57 CR 1/5 166 watts R 134 A
- GFF 66 AA 1/4 195 watts R 134 A
- GFF 75 AA 1/4 + 215 watts R 134 A

▪ BFF 12 AA 1/4 202 watts R 600 A



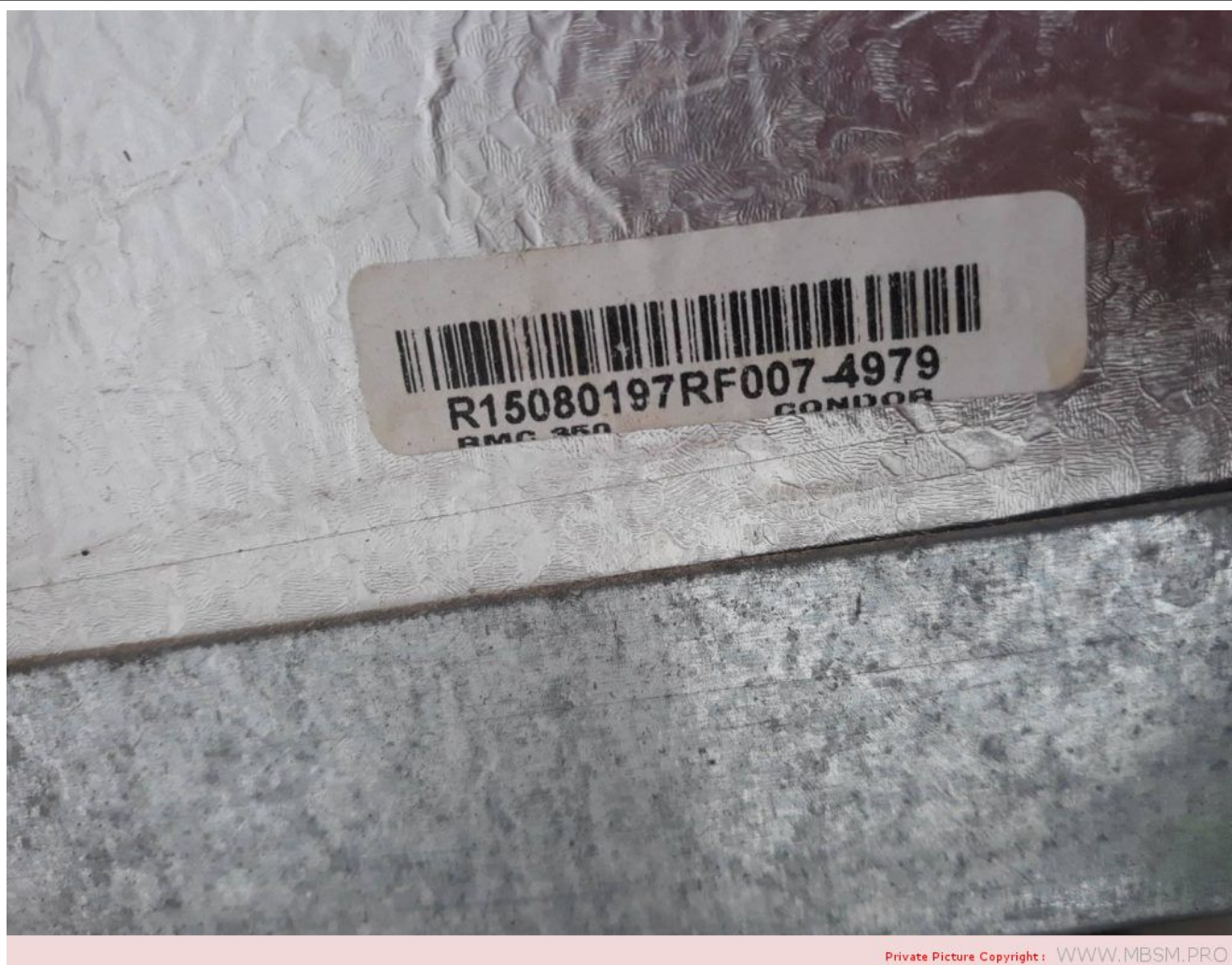

MODÈLE	PUISSANCE HP	TENSION	DÉPLACEMENT (CM <sup>3</sup> )	CAPACITÉ DE REFROIDISSEMENT □W / CAL□	PUISSANCE D'ENTREE □W□	TYPE DE MOTEUR	COPW / W	CHARGE D'HUILE (ML)
GFF44AA	1/6 HP	220 ~ 240V-50Hz	4,6	130/112	99/93	RSIR / RSCR	1,31 / 1,40	1,31 / 1,40
GFF57AA	1 / 5Hp	220 ~ 240V-50Hz	5,7	166/143	122/112	RSIR / RSCR	1,36 / 1,48	200
GFF66AA	1 / 4Hp	220 ~ 240V-50Hz	6,6	195/170	143/132	RSIR / RSCR	1,36 / 1,48	200
GFF75AA	1/4 + Hp	220 ~ 240V-50Hz	7,5	215/185	156/147	RSIR / RSCR	1,38 / 1,46	200
BFF12AA	1 / 4Hp	220 ~ 240V-50Hz	12,0	202/174	130/123	RSIR / RSCR	1,55 / 1,64	200





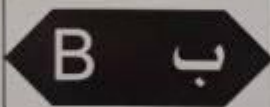



Energie	APRUE	طاقة
Fabricant Modèle	 RMC350	الصانع النموذج
Économe		مقتصد
		
Peu économe		قليل الاقتصاد
Consommation d'énergie kWh/an <small>Sur la base du résultat obtenu pour 24h dans des conditions d'essai normalisées</small>	<b>219</b>	كمية استهلاك الطاقة كيلو واط ساعي في السنة على أساس القيمة المتوسطة لها من طرف 24 ساعة - صفر شروط الامتحان العادية
<small>La consommation réelle dépend des conditions d'utilisation et de la localisation de l'appareil</small>		الاستهلاك الحقيقي يتوقف على ظروف الاستخدام و مكان وجود الجهاز
Capacité de denrées fraîches l Capacité de denrées congelées l	285 30	السعة المخصصة للمواد الباردة ل السعة المخصصة للمواد المجمدة ل
Bruit <small>(dB(A) à 1 m)</small>	≤45	الضجيج <small>(dB(A) à 1 m)</small>
Une fiche d'information		بطاقة معلومات إضافية

Private Picture Copyright : [WWW.MBSM.PRO](http://WWW.MBSM.PRO)



# Compresseur, réfrigérateur, JIAXIPERA, 115W, 1/7HP, R600a, JM1110Y, RSIR, 220-240~/50

written by Lilianne | 16 March 2021



## Specifications

## Description

### Detailed Product Description

- 1.Low levels of noise and vibration
- 2.Standard,medium,high and very high levels of efficiency

Compressor Model	Displ. (cm <sup>3</sup> )	Cooling Type	Motor Type	Vol./Fre. (V~/Hz)	Capacity (W)		COP (W/W)	
					ASHRAE	CECOMAF	ASHRAE	CECOMAF
					(-23.3°C)	(-25°C)	(-23.3°C)	(-25°C)
JM1080Y	6.02	ST	RSIR	220-240~/50	100	75	1.45	1.13
JM1110Y	7.04	ST	RSIR	220-240~/50	115	86	1.25	0.98
JM1111Y	7.70	ST	RSIR	220-240~/50	125	94	1.30	1.01
JK1080Y	6.02	ST	RSCR	220-240~/50	100	75	1.55	1.21
JT1080Y	6.02	ST	RSCR	220-240~/50	95	71	1.65	1.29

## Description

### Detailed Product Description

- 1.Low levels of noise and vibration
- 2.Standard,medium,high and very high levels of efficiency



Compressor Model	Displ. (cm3)	Cooling Type	Motor Type	Vol./Fre. (V~/Hz)	Capacity (W)		COP (W/W)	
					ASHRAE	CECOMAF	ASHRAE	CECOMAF
					(-23.3°C)	(-25°C)	(-23.3°C)	(-25°C)
JM1080Y	6.02	ST	RSIR	220-240~/50	100	75	1.45	1.13
JM1110Y	7.04	ST	RSIR	220-240~/50	115	86	1.25	0.98
JM1111Y	7.70	ST	RSIR	220-240~/50	125	94	1.30	1.01
JK1080Y	6.02	ST	RSCR	220-240~/50	100	75	1.55	1.21
JT1080Y	6.02	ST	RSCR	220-240~/50	95	71	1.65	1.29