

www.mbsm.pro , Réparation , CONTRÔLEUR DE PRESSION JETLY TYPE PRESSCONTROL

written by mahdi miled | 1 September 2018

Démarrage immédiat de la pompe à l'ouverture d'un robinet.

Les contrôleurs de pression JETLY de la série PRESSCONTROL, permettent la suppression des dispositifs de commande et de protection manque d'eau de la pompe (électrodes, flotteurs, contacteurs manométrique). En effet, les PRESSCONTROL sont des systèmes hydrauliques et électroniques conçus pour automatiser et protéger contre le manque d'eau les pompes de surfaces et immergées. Ce système gère automatiquement le fonctionnement de la pompe et l'appareil ne demande ni réglage, ni entretien d'aucune sorte.

www.mbsm.pro , Plomberie , Finition Douche , Installation Multicouche Avec Collecteur

written by mahdi miled | 1 September 2018

www.mbsm.pro, Plomberie, Finition Douche, Installation Multicouche Avec Collecteur

Mbsm.pro, erreur E2 machine a laver Gmc Automatique

written by mahdi miled | 1 September 2018

Pour ce problème, la solution est : switcher de la porte ... certain l'annule complètement ...

www.mbsm.pro , free, For windows, Personal Renamer , Easy filerenaming, Portable Bulk File Renamer, Folder monitor, All in one,

written by mahdi miled | 1 September 2018

www.mbsm.pro , free, For windows, Personal Renamer , Easy filerenaming, Portable Bulk File Renamer, Folder monitor, All in one,

Personal Renamer is being upgraded, and now has an official website Please visit www.personalrenamer.com

Many have waited for this release, more specifically for the addition of the service monitor which has been added to the program in this release. Personal Renamer has always had the

option to monitor a directory and rename files but with this latest addition users can have Personal Renamer monitor a directory invisibly the background, and more importantly while logged out. This is a very powerful and useful addition. Other new features include Undo and the option to apply saved settings when program starts up.

Download Version 2.4.0.0 (Service Beta)

www-mbsm-pro-Personal-Renamer-Easy-filerenaming-Portable-Bulk-File-Renamer-Folder-monitor-All-in-one-1.jpg (279 KB)

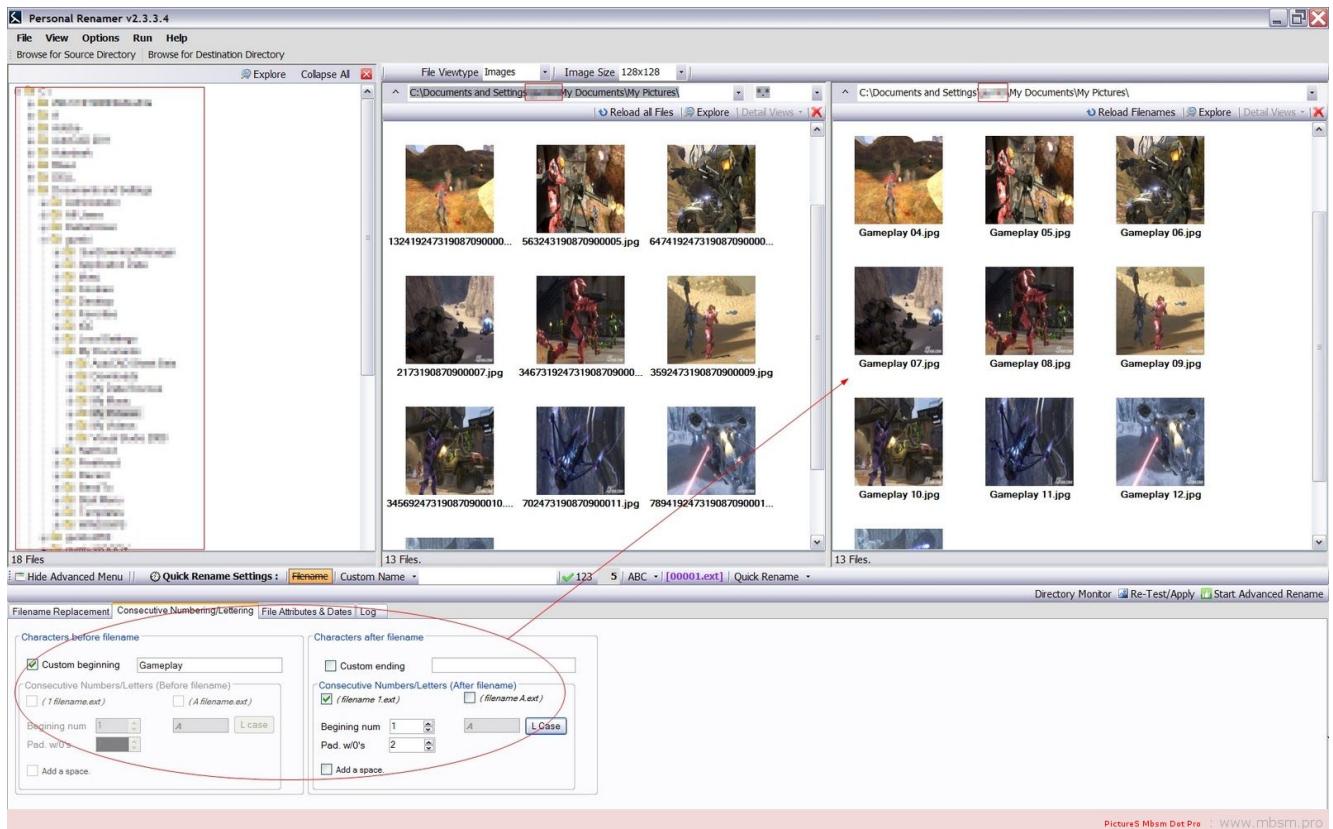

www-mbsm-pro-Personal-Renamer-Easy-filerenaming-Portable-Bulk-File-Renamer-Folder-monitor-All-in-one-1.jpg (223 KB)





www-mbsm-pro-Personal-Renamer-Easy-filerenaming-Portable-Bulk-File-Renamer-Folder-monitor-All-in-one-2.jpg (253 KB)

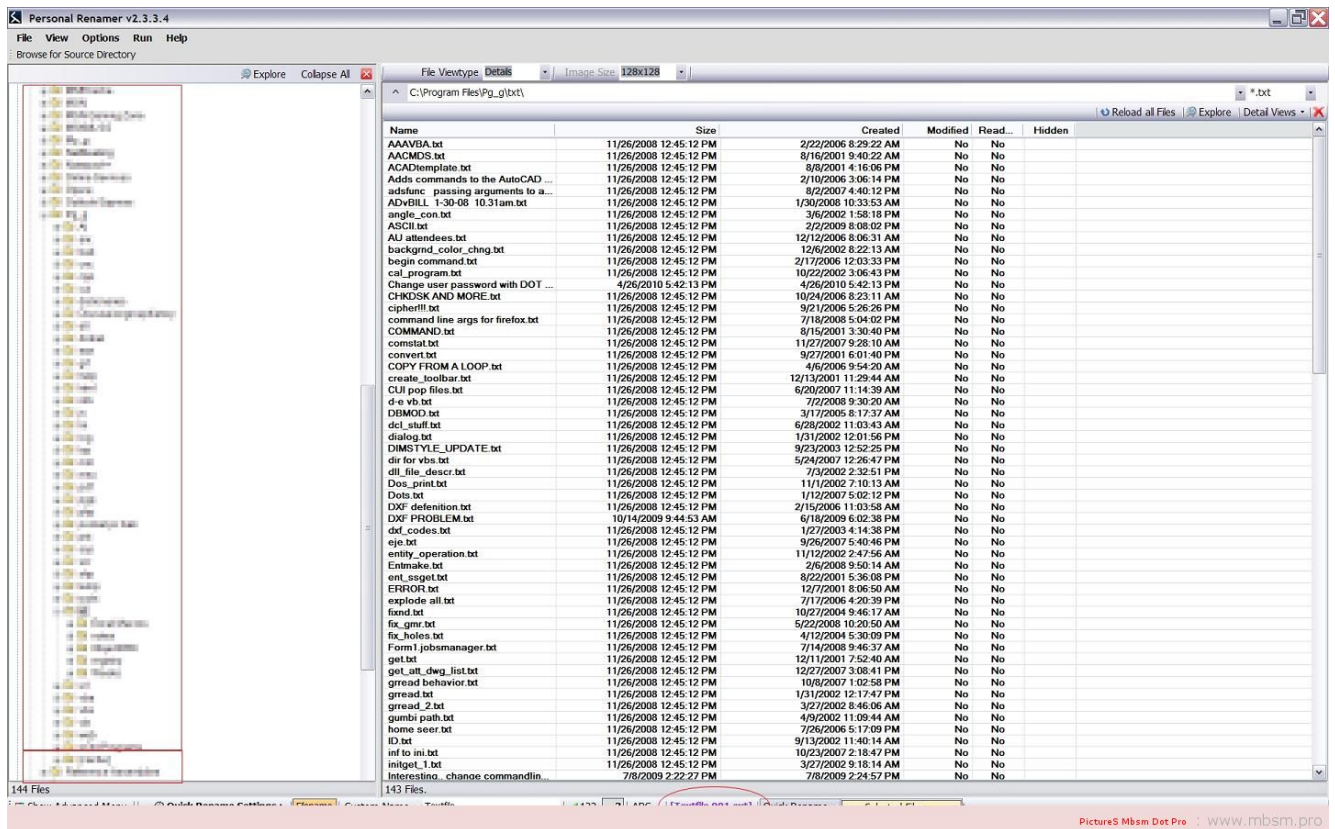

www-mbsm-pro-Personal-Renamer-Easy-filerenaming-Portable-Bulk-File-Renamer-Folder-monitor-All-in-one-2.jpg (261 KB)



www.mbsm.pro , Some Funny Electric pictures part1

written by mahdi miled | 1 September 2018

www.mbsm.pro , Some Funny Electric pictures part1

mbsm-dot-pro-picture-electric -funny1.jpg (37 KB)



PictureS Mbsm Dot Pro : www.mbsm.pro

mbsm-dot-pro-picture-electric -funny1.jpg (47 KB)



mbsm-dot-pro-picture-electric -funny2.jpg (63 KB)



mbsm-dot-pro-picture-electric -funny2.jpg (73 KB)



mbsm-dot-pro-picture-electric -funny3.jpg (121 KB)



mbsm-dot-pro-picture-electric -funny3.jpg (124 KB)



mbsm-dot-pro-picture-electric -funny4.jpg (145 KB)



mbsm-dot-pro-picture-electric -funny4.jpg (133 KB)



mbsm-dot-pro-picture-electric -funny5.jpg (117 KB)



mbsm-dot-pro-picture-electric -funny5.jpg (129 KB)

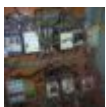
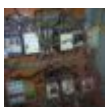

mbsm-dot-pro-picture-electric -funny6.jpg (23 KB)



mbsm-dot-pro-picture-electric -funny6.jpg (27 KB)



mbsm-dot-pro-picture-electric -funny7.jpg (62 KB)



mbsm-dot-pro-picture-electric -funny7.jpg (72 KB)



mbsm-dot-pro-picture-electric -funny8.jpg (31 KB)



mbsm-dot-pro-picture-electric -funny8.jpg (33 KB)



www.mbsm.pro , Quelle est la différence entre le SDS PLUS et le SDS MAX ?

written by mahdi miled | 1 September 2018

Lorsque vous choisissez un outil, vous aurez donc le choix entre la fixation par mandrin classique (avec ou sans clé de serrage) et par mandrin SDS avec les variantes SDS PLUS et SDS MAX.

Attention, vos accessoires classiques ne seront pas adaptés aux système SDS et inversement ! Le système SDS accueille en effet des mèches/forets avec cannelures qui s'encastrent dans le mandrin et permettent une fixation plus fiable que les forets classiques qui finissent par «glisser dans le mandrin», particulièrement lors de gros travaux (forage / percussion sur de la pierre)

**www.mbsm.pro , Pompe
hydrauliques volumétriques
double à engrenage interne à
gérotor (orifices
indépendants) .**

written by Lilianne | 1 September 2018



PictureS Mbsm Dot Pro : www.mbsm.pro

Il existe plusieurs types de pompes hydrauliques

volumétriques.

A chaque type de pompe correspondent une nature et un agencement particulier des pièces mobiles internes.



Quel qu'en soit le type, une pompe hydraulique remplit essentiellement le même rôle, c'est celui de faire circuler un liquide.

Le fonctionnement de tous les types de pompes repose sur le même principe:

- Lorsque la pompe est mise en marche par l'intermédiaire de **sa source motrice**, les pièces **mobiles internes se déplacent et attirent l'air** qui se trouve dans la canalisation du côté de **l'admission de la pompe**.
- Ce mouvement des pièces internes crée **un vide partiel**.
- La pression atmosphérique agit alors sur la surface du liquide contenu dans le réservoir en poussant **ce fluide vers l'admission de la pompe**.
- Le fluide est ensuite entraîné par les pièces mobiles et finalement refoulé vers le système hydraulique à actionner.

Ce cours porte sur les différents types de pompes hydrauliques volumétriques:

- Pompes à engrenage,
- pompes à palettes,
- pompes à pistons.

Vous verrez quelles sont les pièces mobiles qui caractérisent ces divers types de pompes ainsi que l'interaction de ces composants.

Pompes à engrenage

Les pompes hydrauliques volumétriques à engrenage sont de

constitution simple parce qu'elles ne possèdent que peu de pièces mobiles internes.

Ce type de pompe:

- présente l'avantage d'être celui le **moins coûteux**.
- offre un **rendement** volumétrique **peu élevé**.
- est à **cyindrée fixe**.

D'une manière générale, les pompes à engrenage présentent deux inconvénients :

1. lorsqu'elles sont sollicitées à de faibles débits, ceux-ci sont irréguliers avec pour conséquence **d'agir sur le niveau sonore**.
2. à cause des fuites internes affectant le rendement volumique, elles ne peuvent être utilisées en cas de hautes pressions, ce qui entraîne des pressions de refoulement n'excédant pas 250 bars.

Ces pompes sont à débit constant de par leur conception.

Comme le nom l'indique, les pompes à engrenage renferment deux roues dentées qui s'engrènent (s'engagent) l'une dans l'autre.

Il existe deux catégories de pompes à engrenage :

1. les pompes à engrenage externe ;
2. les pompes à engrenage interne.

Pompes à engrenage externe: principe

Les pompes à engrenage externe tirent leur nom de la position de leurs roues dentées.

Ces roues sont placées l'une à côté de l'autre et s'engagent l'une dans l'autre par leurs dents se trouvant sur leur circonférence (figure 1.9).

Figure 1.9 Principe de fonctionnement d'une pompe à engrenage.

Les pompes à engrenage externe comportent:

- une roue **dentée menée**:
- La **roue dentée menante** reçoit son mouvement d'un moteur.

Ces roues tournent en sens opposé en s'engrenant l'une dans l'autre.

En face de l'orifice d'admission, les deux roues dentées se séparent en créant un vide partiel comblé par l'huile provenant du réservoir.

L'huile est ensuite transportée par les alvéoles formées par le creux des dents et le corps de la pompe.

Des plaquettes assurent l'étanchéité axiale des alvéoles, c'est-à-dire qu'elles empêchent l'huile de fuir par les côtés des alvéoles.

Au fur et à mesure que les dents se réengagent, l'huile est évacuée vers l'orifice de refoulement.

La figure 1.9 donne le principe de fonctionnement d'une pompe à engrenage. (appuyer sur Marche)

Sous l'effet de la pression existant du côté du refoulement de la pompe, les deux roues dentées sont poussées contre le corps de la pompe à cause de l'espace existant entre la face des dents des roues dentées et le corps de la pompe.

L'engrènement précis des dents assure l'étanchéité entre l'aspiration et le refoulement et réduit les fuites internes à un niveau minimum.

- L'espace disponible tend à **s'amplifier** à mesure que **la pompe prend de l'âge** et s'use.
- **Les pertes volumétriques augmentent** donc en fonction de l'usure de la pompe.

- Il en résulte **un faible rendement volumétrique.**

Pompes à engrenage externe:construction

La figure 1.10 vous montre une vue éclatée d'une pompe à engrenage externe. Vous pouvez y remarquer la plaquette d'étanchéité qui assure l'étanchéité axiale de la pompe.

Figure 1.10 Vue éclatée d'une pompe à engrenage externe.

cliquez sur les éléments pour avoir leur définition.

Parker

La figure 1.11 présente une vue en coupe d'une pompe à engrenage externe.

Figure 1.11 Vue en coupe d'une pompe à engrenage externe.

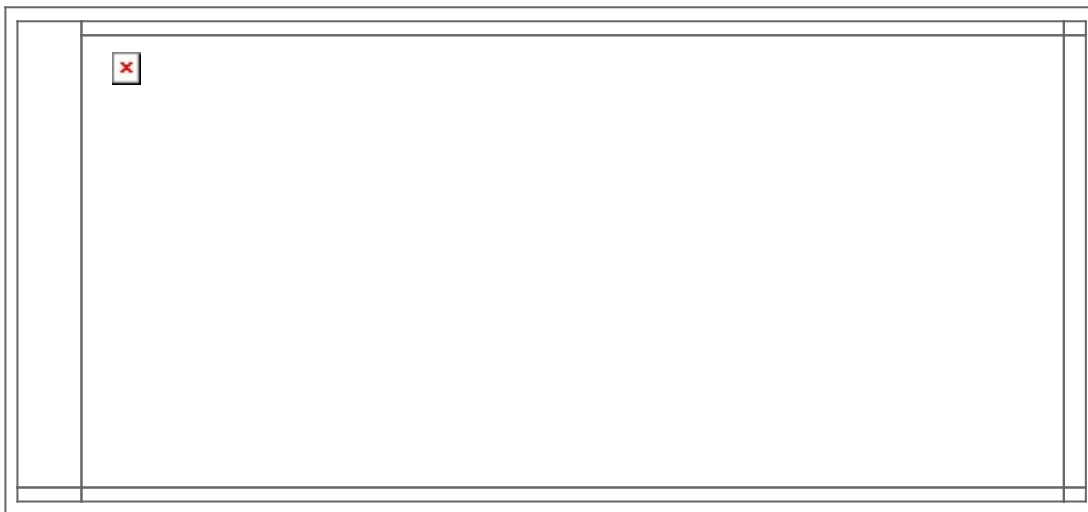

Il existe également des pompes à engrenage externe double.

Une pompe à engrenage double est en fait l'union de deux pompes à engrenage, lesquelles sont entraînées par le même arbre d'accouplement.

La figure 1.12 vous montre une vue en coupe d'une pompe à engrenage externe double.

Figure 1.12 Pompe à engrenage externe double.

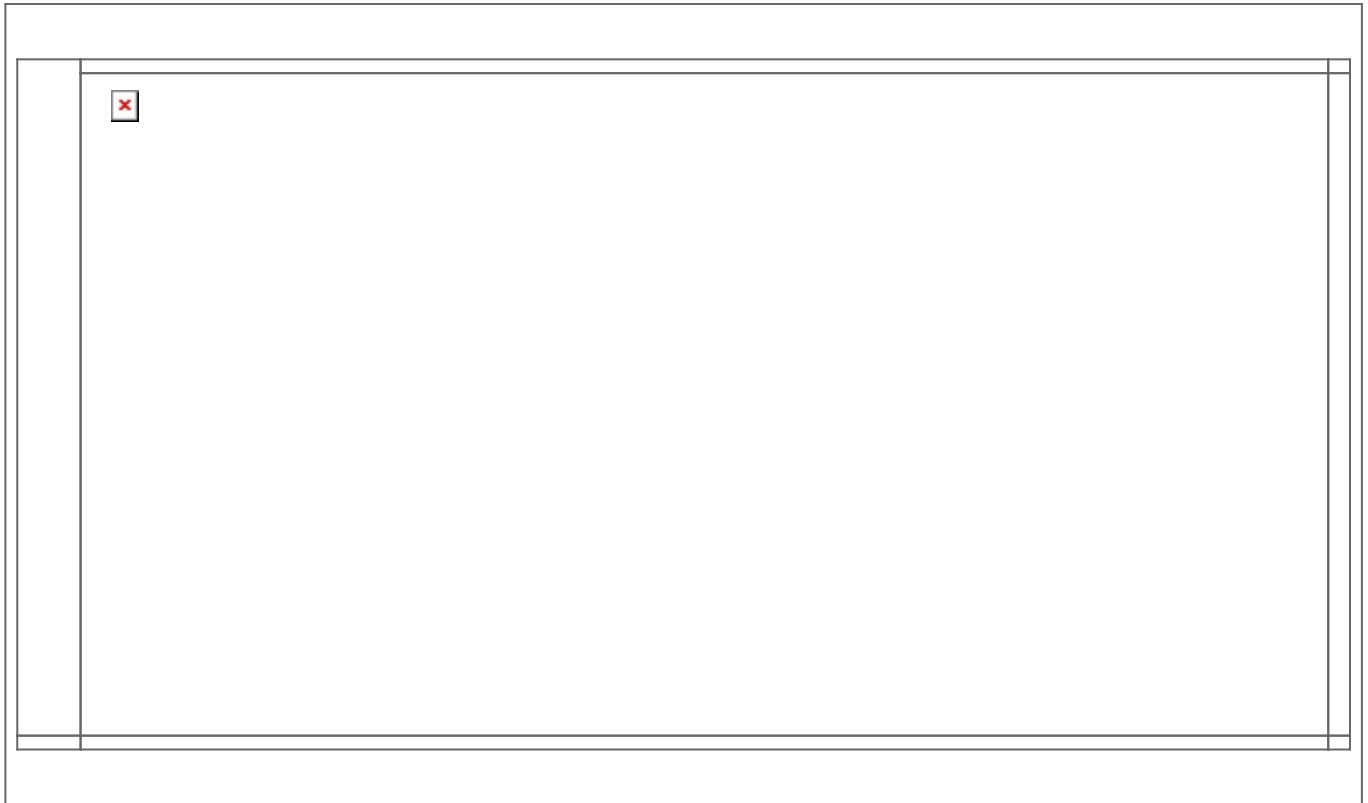

Bosch

Les pompes à engrenage externe double ont les mêmes caractéristiques de fonctionnement qu'une pompe à engrenage externe simple:

- Elles possèdent un seul orifice d'admission commun aux deux pompes.
- Chacune des pompes fournit son propre débit par son propre orifice de refoulement.

Une pompe à engrenage externe double **peut alimenter deux circuits hydrauliques indépendants** ou fournir **un plus grand débit** à un seul circuit.

Le montage d'une pompe triple est également possible.

Vous pouvez voir à la figure 1.13 les symboles utilisés pour représenter les pompes simples, doubles et triples.

Notez que ces symboles concernent tous les types de pompes.

Figure 1.13 Symboles standards des pompes.

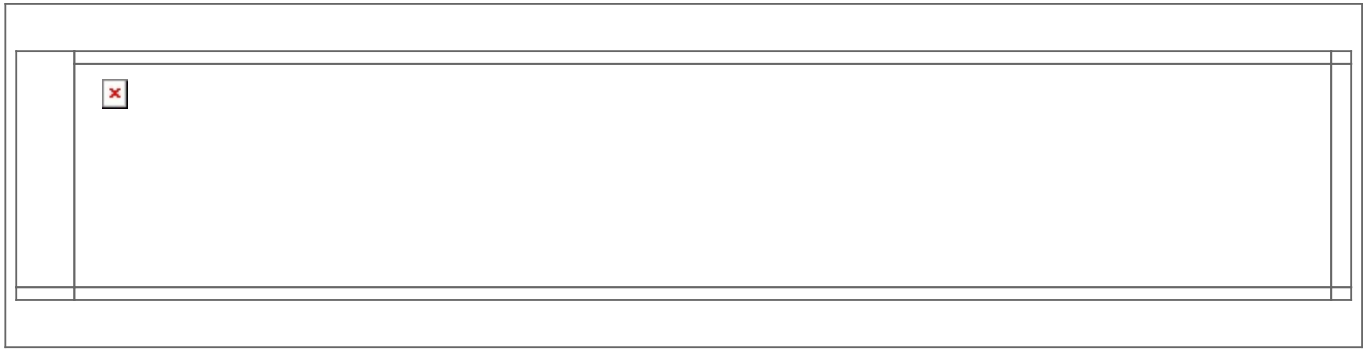

Axcom

Pompes à engrenage interne

Les pompes à engrenage interne tirent leur nom du fait qu'elles possèdent comme pièce mobile une roue à denture interne (figure 1.14).

Figure 1.14 Roue à denture interne.

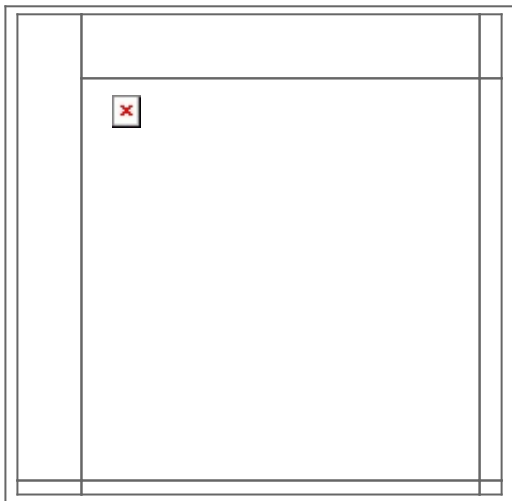

Il existe deux principaux types de pompes à engrenage interne :

1. les pompes à engrenage interne à **croissant** ;
2. **les pompes à engrenage interne à gérotor.**

Pompes à engrenage interne à croissant

La pompe à engrenage interne à croissant comprend deux roues à denture:

- une roue à denture **interne**

- une roue à denture **externe**,

Ces roues sont séparées par un croissant fixe.

- La roue à denture externe entraîne la roue à denture interne.
- la roue à denture externe est excentrique par rapport à la roue à denture interne;
- les deux roues dentées tournent dans le même sens.

La figure 1.15 représente le principe de fonctionnement d'une pompe à engrenage interne à croissant.

Figure 1.15 Principe de fonctionnement d'une pompe à engrenage interne à croissant.

Vickers

Il existe des pompes double ou triple à engrenage interne à croissant.

Pompes à engrenage interne à gérotor

Le fonctionnement des pompes à engrenage interne à gérotor ressemble beaucoup à celui des pompes à engrenage interne à croissant.

La figure 1.16 vous présente le cycle de fonctionnement.

Figure 1.16 Cycle de fonctionnement d'une pompe à engrenage interne à gérotor.



Sur cette figure:

- **le lobe en pointillé de gauche représente l'orifice de refoulement,**
- **tandis que celui de droite représente l'orifice d'admission (partie A de la figure 1.16).**

Fonctionnement:

1. La rotation des deux roues dentées se fait dans le sens des aiguilles d'une montre (sens horaire).
2. Le fluide hydraulique est aspiré par la cavité créée lors du désengagement des deux roues dentées.
3. Le désengagement s'effectue vis-à-vis de l'orifice d'admission (parties B et C de la figure 1.16).
4. Le fluide devient prisonnier dans l'alvéole créée entre les roues à denture externe et interne (partie D de la figure 1.16).
5. Lors du réengagement des deux roues à denture (parties E, F et G de la figure 1.16), le fluide est refoulé vers l'orifice de refoulement.
6. Le cycle, ainsi complété, recommence.

La figure 1.17 vous présente une vue en coupe d'une pompe à engrenage interne à gérotor.

Figure 1.17 Vue en coupe d'une pompe à engrenage interne à gérotor.

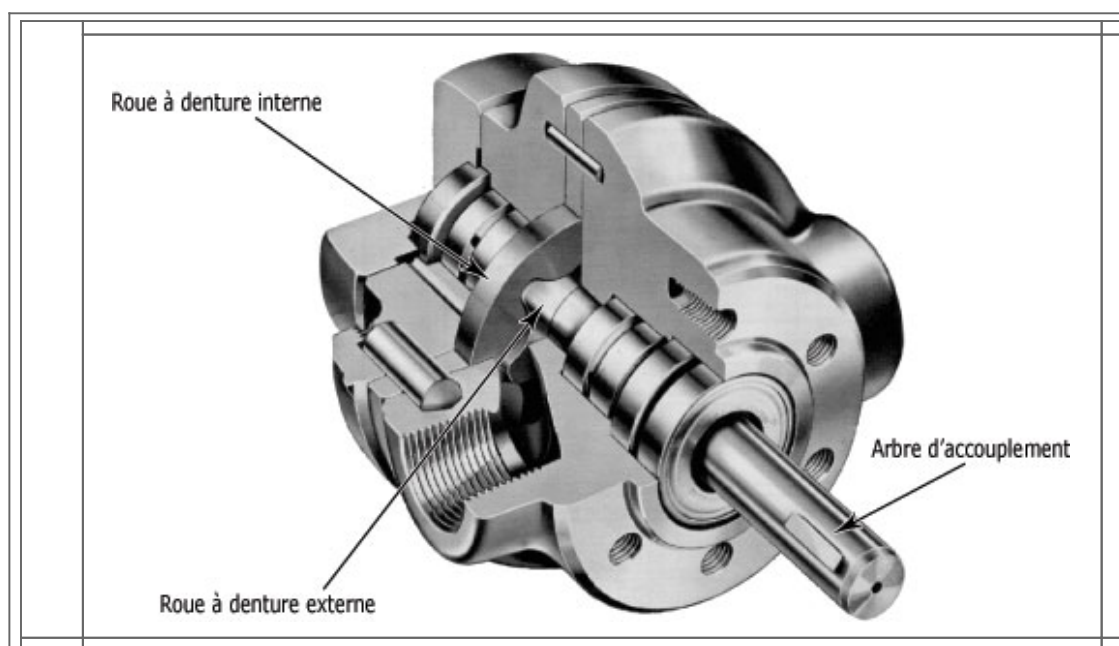

Il existe également des pompes doubles à engrenage interne à gérotor.

Certaines de ces pompes possèdent deux orifices d'admission indépendants et deux orifices de refoulement indépendants. figure 1.18

Figure 1.18 Pompe double à engrenage interne à gérotor (orifices indépendants).

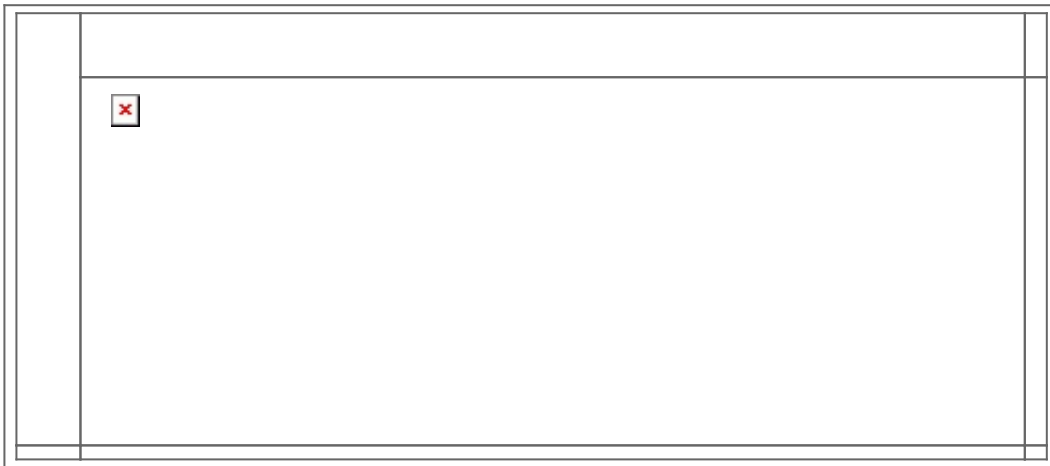

D'autres pompes du même type possèdent un seul orifice d'admission et un seul orifice de refoulement. figure 1.19.

Figure 1.19 Pompe double à engrenage interne à gérotor (orifices communs).



Dans le cas des pompes doubles à un seul orifice d'admission et un seul orifice de refoulement, **l'admission et le refoulement se divisent en deux à l'intérieur du carter de la pompe.**

Pompes à palettes

Les pompes hydrauliques volumétriques à palettes sont fréquemment utilisées parce qu'elles ont un bon rendement volumétrique :

- Elles offrent généralement **un meilleur rendement volumétrique** que les pompes à engrenage.
- Elles sont toutefois plus **coûteuses** que ces dernières.

Les pompes à palettes renferment des palettes:

- Celles-ci sont de forme rectangulaire;
- et sont introduites à l'intérieur du rotor par l'entremise de rainures radiales (figure 1.23). Les palettes peuvent donc se déplacer radialement.

Figure 1.23 Rotor d'une pompe hydraulique volumétrique à palettes.

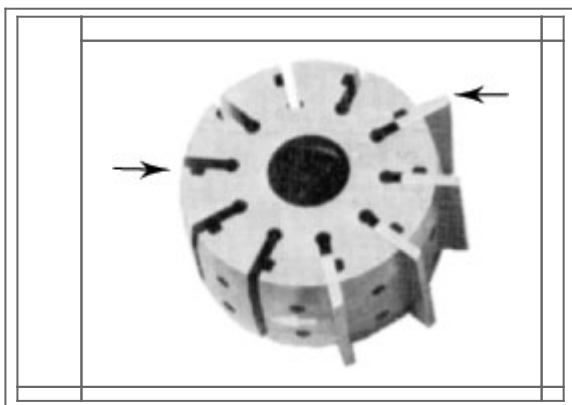

Vickers

Il existe deux catégories de pompes à palettes :

1. les pompes à palettes à cylindrée fixe;
2. les pompes à palettes à cylindrée variable.

Pompes à palettes à cylindrée fixe

Les pompes à palettes à cylindrée fixe se divisent en deux

groupes :

1. les pompes à palettes à cylindrée fixe à rotor non balancé;
2. les pompes à palettes à cylindrée fixe à rotor balancé.

Pompes à palettes à cylindrée fixe à rotor non balancé

Les pompes à palettes à cylindrée fixe à rotor non balancé La figure 1.24 ont un principe de fonctionnement relativement simple:

- Le rotor dans lequel sont introduites les palettes, est installé dans le carter de la pompe.
- Il est excentrique par rapport au centre du corps de la pompe.

Figure 1.24 Principe de fonctionnement d'une pompe à palettes à cylindrée fixe à rotor non balancé.

Fonctionnement:

Le rotor est entraîné dans un mouvement de rotation grâce à l'arbre d'accouplement relié à la source motrice de la pompe.

La force centrifuge, ainsi créée, pousse les palettes contre une couronne circulaire. Lorsque le rotor tourne, les palettes suivent le contour de la couronne. Il est à noter que le **chanfrein** de la palette suit toujours le sens de rotation. Il en est ainsi pour tous les types de pompes à palettes.

A cause **de l'excentricité du rotor** par rapport à la couronne, **les palettes divisent l'espace compris entre le rotor et la couronne en une série d'alvéoles**. L'aspiration de la pompe se fait à l'endroit où les alvéoles augmentent de volume. **Il se crée ainsi un vide partiel** qui

www.mbsm.pro , Porte-fusible à couteaux HPC ultra rapide

written by mahdi miled | 1 September 2018

Généralités

Généralités

Les cartouches-fusible HPC des classes de fonctionnement gG et gL protègent les appareils électriques des sur charges et des courts-circuits. Elles sont destinées avant tout à la protection des circuits électriques basse tension. Ces classes de fonctionnement gG et gL impliquent la coupure en toute sécurité de tout courant capable de faire fondre le fusible.

mbsmdotpro- porte-fusible-couteaux-ultra-rapide.jpg (83 KB)



Picture5 Mbsm Dot Pro : www.mbsm.pro

mbsmdotpro- porte-fusible-couteaux-ultra-rapide.jpg (91 KB)



www.mbsm.pro , Practical Electronics for Inventors, Fourth Edition

written by mahdi miled | 1 September 2018

Practical Electronics for Inventors, Fourth Edition

by: Paul Scherz, Dr. Simon Monk

Abstract: A fully updated, no-nonsense guide to electronics. Advance your electronics knowledge and gain the skills necessary to develop and construct your own functioning gadgets. Written by a pair of experienced engineers and dedicated hobbyists, Practical Electronics for Inventors, Fourth Edition, lays out the essentials and provides step-by-step instructions, schematics, and illustrations. Discover how to select the right components, design and build circuits, use microcontrollers and ICs, work with the latest software tools, and test and tweak your creations. This easy-to-follow book features new instruction on programmable logic, semiconductors, operational amplifiers, voltage regulators, power supplies, digital electronics, and more. Coverage includes:

- Resistors, capacitors, inductors, and transformers
- Diodes, transistors, and integrated circuits
- Optoelectronics, solar cells, and phototransistors
- Sensors, GPS modules, and touch screens
- Op amps, regulators, and power supplies
- Digital electronics, LCDs, and logic gates
- Microcontrollers and prototyping platforms
- Combinational and sequential programmable logic
- DC motors, RC servos, and stepper motors
- Microphones, audio amps, and speakers
- Modular electronics and prototypes

Book Details

Title: Practical Electronics for Inventors, Fourth Edition

Publisher: McGraw-Hill Education: New York, Chicago, San Francisco, Athens, London, Madrid, Mexico City, Milan, New Delhi, Singapore, Sydney, Toronto

Copyright / Pub. Date: 2016 McGraw-Hill Education

ISBN: 9781259587542

Authors:

Paul Scherz is a Systems Operation Manager who received his B.S. in physics from the University of Wisconsin. He is an inventor/hobbyist in electronics, an area he grew to appreciate through his experience at the University's Department of Nuclear Engineering and Engineering Physics and Department of Plasma Physics.

Dr. Simon Monk has a bachelor's degree in cybernetics and computer science and a Ph.D. in software engineering. He spent several years as an academic before he returned to industry, co-founding the mobile software company Momote Ltd. He has been an active electronics hobbyist since his early teens and is a full-time writer on hobby electronics and open-source hardware. Dr. Monk is author of numerous electronics books, including Programming Arduino, Hacking Electronics, and Programming the Raspberry Pi.

Description: A fully updated, no-nonsense guide to electronics. Advance your electronics knowledge and gain the skills necessary to develop and construct your own functioning gadgets. Written by a pair of experienced engineers and dedicated hobbyists, Practical Electronics for Inventors, Fourth Edition, lays out the essentials and provides step-by-step instructions, schematics, and illustrations. Discover how

to select the right components, design and build circuits, use microcontrollers and ICs, work with the latest software tools, and test and tweak your creations. This easy-to-follow book features new instruction on programmable logic, semiconductors, operational amplifiers, voltage regulators, power supplies, digital electronics, and more. Coverage includes:

- Resistors, capacitors, inductors, and transformers
- Diodes, transistors, and integrated circuits
- Optoelectronics, solar cells, and phototransistors
- Sensors, GPS modules, and touch screens
- Op amps, regulators, and power supplies
- Digital electronics, LCDs, and logic gates
- Microcontrollers and prototyping platforms
- Combinational and sequential programmable logic
- DC motors, RC servos, and stepper motors
- Microphones, audio amps, and speakers
- Modular electronics and prototypes

Table of Contents

A. ABOUT THE AUTHORS

B. PREFACE

C. ACKNOWLEDGMENTS

1. Introduction to Electronics
2. Theory
3. Basic Electronic Circuit Components
4. Semiconductors
5. Optoelectronics
6. Sensors
7. Hands-on Electronics
8. Operational Amplifiers
9. Filters
10. Oscillators and Timers
11. Voltage Regulators and Power Supplies
12. Digital Electronics
13. Microcontrollers
14. Programmable Logic
15. Motors
16. Audio Electronics

17. Modular Electronics

A. Power Distribution and Home Wiring

B. Error Analysis

C. Useful Facts and Formulas

Tools & Media

figure (1 036)

table (64)

Expanded Table of Contents

A. ABOUT THE AUTHORS

PREFACE PRELIMINARIES

ABOUT THE TECHNICAL EDITORS

B. PREFACE

PREFACE PRELIMINARIES

Notes about the Fourth Edition

C. ACKNOWLEDGMENTS

1. Introduction to Electronics

CHAPTER PRELIMINARIES

2. Theory

CHAPTER PRELIMINARIES

Theory of Electronics

Electric Current

Voltage

A Microscopic View of Conduction (for Those Who Are Interested)

Resistance, Resistivity, Conductivity

Insulators, Conductors, and Semiconductors

Heat and Power

Thermal Heat Conduction and Thermal Resistance

Wire Gauges

Grounds

Electric Circuits

Ohm's Law and Resistors

Voltage and Current Sources

Measuring Voltage, Current, and Resistance

Combining Batteries
Open and Short Circuits
Kirchhoff's Laws
Superposition Theorem
Thevenin's and Norton's Theorems
AC Circuits
AC and Resistors, RMS Voltage, and Current
Mains Power
Capacitors
Inductors
Modeling Complex Circuits
Complex Numbers
Circuit with Sinusoidal Sources
Power in AC Circuits (Apparent Power, Real Power, Reactive Power)
Thevenin's Theorem in AC Form
Resonant Circuits
Lecture on Decibels
Input and Output Impedance
Two-Port Networks and Filters
Transient Circuits
Circuits with Periodic Nonsinusoidal Sources
Nonperiodic Sources
SPICE

3. Basic Electronic Circuit Components

CHAPTER PRELIMINARIES

Wires, Cables, and Connectors
Batteries
Switches
Relays
Resistors
Capacitors
Inductors
Transformers
Fuses and Circuit Breakers

4. Semiconductors

CHAPTER PRELIMINARIES

Semiconductor Technology

Diodes

Transistors

Thyristors

Transient Voltage Suppressors

Integrated Circuits

5. Optoelectronics

CHAPTER PRELIMINARIES

A Little Lecture on Photons

Lamps

Light-Emitting Diodes

Photoresistors

Photodiodes

Solar Cells

Phototransistors

Photothyristors

Optoisolators

Optical Fiber

6. Sensors

CHAPTER PRELIMINARIES

General Principles

Temperature

Proximity and Touch

Movement, Force, and Pressure

Chemical

Light, Radiation, Magnetism, and Sound

GPS

7. Hands-on Electronics

CHAPTER PRELIMINARIES

Safety

Constructing Circuits

Multimeters

Oscilloscopes

The Electronics Laboratory

8. Operational Amplifiers

CHAPTER PRELIMINARIES

Operational Amplifier Water Analogy

How Op Amps Work (The “Cop-Out” Explanation)

Theory

Negative Feedback

Positive Feedback

Real Kinds of Op Amps

Op Amp Specifications

Powering Op Amps

Some Practical Notes

Voltage and Current Offset Compensation

Frequency Compensation

Comparators

Comparators with Hysteresis

Using Single-Supply Comparators

Window Comparator

Voltage-Level Indicator

Instrumentation Amplifiers

Applications

9. Filters

CHAPTER PRELIMINARIES

Things to Know Before You Start Designing Filters

Basic Filters

Passive Low-Pass Filter Design

A Note on Filter Types

Passive High-Pass Filter Design

Passive Bandpass Filter Design

Passive Notch Filter Design

Active Filter Design

Integrated Filter Circuits

10. Oscillators and Timers

CHAPTER PRELIMINARIES

RC Relaxation Oscillators

The 555 Timer IC

Voltage-Controlled Oscillators

Wien-Bridge and Twin-T Oscillators

LC Oscillators (Sinusoidal Oscillators)

Crystal Oscillators

Microcontroller Oscillators

11. Voltage Regulators and Power Supplies

CHAPTER PRELIMINARIES

Voltage-Regulator ICs

A Quick Look at a Few Regulator Applications

The Transformer

Rectifier Packages

A Few Simple Power Supplies

Technical Points about Ripple Reduction

Loose Ends

Switching Regulator Supplies (Switchers)

Switch-Mode Power Supplies (SMPS)

Kinds of Commercial Power Supply Packages

Power Supply Construction

12. Digital Electronics

CHAPTER PRELIMINARIES

The Basics of Digital Electronics

Logic Gates

Combinational Devices

Logic Families

Powering and Testing Logic ICs

Sequential Logic

Counter ICs

Shift Registers

Analog/Digital Interfacing

Displays

Memory Devices

13. Microcontrollers

CHAPTER PRELIMINARIES

Basic Structure of a Microcontroller

Example Microcontrollers

Evaluation/Development Boards

Arduino

Interfacing with Microcontrollers

14. Programmable Logic

CHAPTER PRELIMINARIES

Programmable Logic

FPGAs

ISE and the Elbert V2

The Elbert 2 Board

Downloads

Drawing Your FPGA Logic Design

Verilog

Describing Your FPGA Design in Verilog

Modular Design

Simulation

VHDL

15. Motors

CHAPTER PRELIMINARIES

DC Continuous Motors

Speed Control of DC Motors

Directional Control of DC Motors

RC Servos

Stepper Motors

Kinds of Stepper Motors

Driving Stepper Motors

Controlling the Driver with a Translator

A Final Word on Identifying Stepper Motors

16. Audio Electronics

CHAPTER PRELIMINARIES

A Little Lecture on Sound

Microphones

Microphone Specifications

Audio Amplifiers

Preamplifiers

Mixer Circuits

A Note on Impedance Matching

Speakers

Crossover Networks

Simple ICs Used to Drive Speakers

Audible-Signal Devices

Miscellaneous Audio Circuits

17. Modular Electronics

CHAPTER PRELIMINARIES

There's an IC for It

Breakout Boards and Modules

Plug-and-Play Prototyping

Open Source Hardware

A. Power Distribution and Home Wiring

APPENDIX PRELIMINARIES

Power Distribution

A Closer Look at Three-Phase Electricity

Home Wiring

Electricity in Other Countries

B. Error Analysis

APPENDIX PRELIMINARIES

Absolute Error, Relative Error, and Percent Error

Uncertainty Estimates

C. Useful Facts and Formulas

APPENDIX PRELIMINARIES

Greek Alphabet

Powers of 10 Unit Prefixes

Linear Functions ($y = mx + b$)

Quadratic Equation ($y = ax^2 + bx + c$)

Exponents and Logarithms

Trigonometry

Complex Numbers

Differential Calculus

Integral Calculus

1

1. <https://www.amazon.com/Practical-Electronics-Inventors-Fourth-Scherz/dp/1259587541> [back]

www-mbsm-pro-Practical-Electronics-for-Inventors-Fourth-Edition1.png (273 KB)

FOURTH EDITION

PRACTICAL ELECTRONICS FOR INVENTORS



PictureS Mbsm Dot Pro : www.mbsm.pro

[www-mbsm-pro-Practical-Electronics-for-Inventors-Fourth-Edition1.png](#) (239 KB)



www-mbsm-pro-Practical-Electronics-for-Inventors-Fourth-Edition2.png (121 KB)

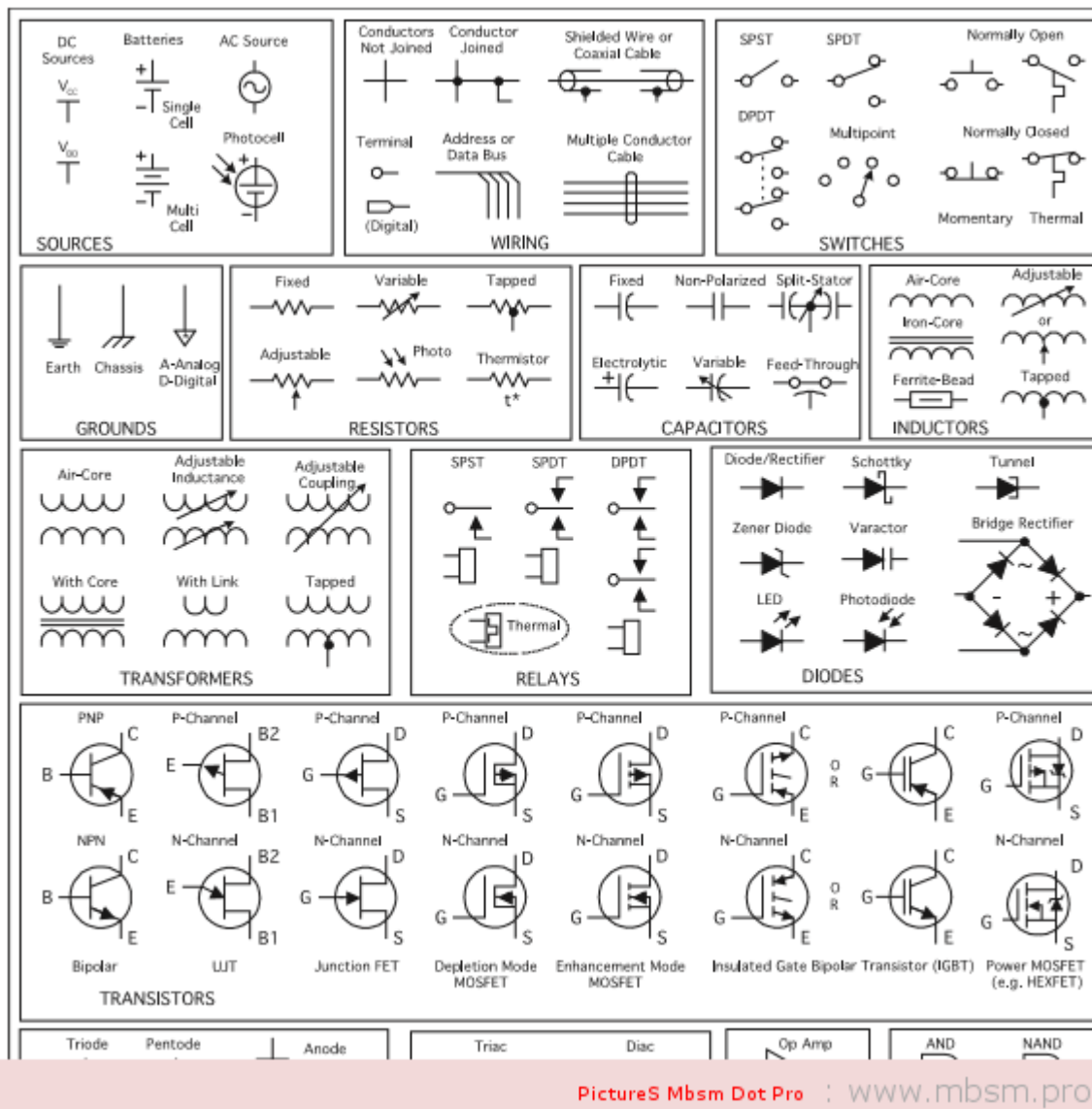

www-mbsm-pro-Practical-Electronics-for-Inventors-Fourth-Edition2.png (111 KB)





www-mbsm-pro-Practical-Electronics-for-Inventors-Fourth-Edition3.png (146 KB)

Resistor Labels

Conversion Calculator

k = 1,000 ; M = 1,000,000

1MΩ = 1,000,000 Ω = 1 x 10⁶Ω

1kΩ = 1,000 Ω = 1 x 10³Ω

Examples:

3.3 kΩ = 3,300 Ω = 3.3 x 10³Ω

22 kΩ = 22,000 Ω = 22 x 10³Ω

2 MΩ = 2,000,000 Ω = 2 x 10⁶Ω

1.68 MΩ = 1,680,000 Ω = 1.68 x 10⁶Ω

Resistor Color Code

Color	Sig. Fig.	Decimal Multiplier	Tolerance (%)
Black	0	1	-
Brown	1	10	1
Red	2	100	2
Orange	3	1,000	-
Yellow	4	10,000	-
Green	5	100,000	0.5
Blue	6	1,000,000	0.25
Purple	7	10,000,000	0.1
Gray	8	100,000,000	-
White	9	1,000,000,000	-
Gold	-	0.1	5
Silver	-	0.01	10
No Color	-	-	20

Body Color

The body color of a resistor typically doesn't carry meaning, except in some instances where it may specify temperature coefficient. However, if you find resistors within a circuit that are white/gray or blue in color, they may be non-flammable or fusible resistors. Care must be taken when entering such resistors.

4-Band Resistor Code (Most Common)

Label Meaning

Red Black Orange Gold
20 x 1,000 = 20k Ω ± 5%

First Digit: Red, Second Digit: Black, Multiplier (x of zeros): Orange, % Tolerance: Gold

5-Band Resistor Code (3-digit)

Label Meaning

Purple Blue Green Brown Brown
675 x 10 = 6750 Ω ± 1%

First Digit: Purple, Second Digit: Blue, Third Digit: Green, Multiplier (x of zeros): Brown, % Tolerance: Brown

5-Band Resistor Code (Reliability)

Label Meaning

Yellow Purple Green Silver Brown
47 x 100,000 = 4.7 MΩ ± 10%

1% Reliability/1000 Hr — Brown

Color	Reliability (%/1000 Hr)
Brown	1
Red	0.1
Orange	0.01
Yellow	0.001

First Digit: Yellow, Second Digit: Purple, Multiplier (x of zeros): Green, Reliability: Silver, % Tolerance: Brown

6-Band Resistor Code

Label Meaning

Purple Red Black Blue Brown Red
276 x 1 = 276Ω ± 1%

TC of 50 ppm — Red

Color	Temp. Coeff.
Brown	100 ppm
Red	50 ppm

First Digit: Purple, Second Digit: Red, Third Digit: Black, Temp. Coeff.: Blue, % Tolerance: Brown

Surface Mount Resistor Code

3-digit Label

Label Meaning

101: 10 and 1 zero = 100 Ω

105: 10 and 5 zero = 1,000,000 Ω

224: 22 and 4 zeros = 220,000 Ω

1R0: 1.0 and no zeros = 1 Ω

22R: 22.0 and no zeros = 22 Ω

R10: 0.1 and no zeros = 0.1 Ω

The first two digits represent significant figures; the last digit specifies the multiplier. For values under 100 Ω, the letter R is substituted for one of the significant digits and represents a decimal point.

4-digit Label

Label Meaning

1001: 100 and 1 zero = 1000 Ω

22R0: 22.0 and no zeros = 22 Ω

The first three digits represent significant figures; the last digit specifies the multiplier. R represents a decimal point.

Tolerance Label

Label Meaning	Letter	Tolerance
101F	D	±0.5 %
	F	±1.0 %

PictureS Mbsm Dot Pro : www.mbsm.pro

www-mbsm-pro-Practical-Electronics-for-Inventors-Fourth-Edition3.png (134 KB)

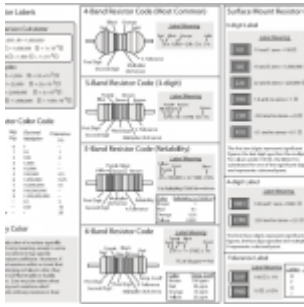
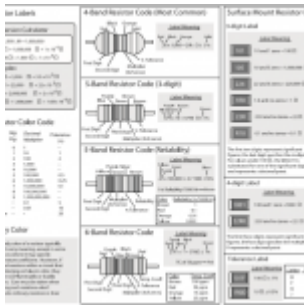

www-mbsm-pro-Practical-Electronics-for-Inventors-Fourth-Edition4.png (193 KB)

Capacitor Markings

Capacitance Conversion Calculator

$1\text{ F} = 1 \times 10^6 \mu\text{F} = 1 \times 10^9 \text{ nF} = 1 \times 10^{12} \text{ pF}$
 $1 \mu\text{F} = 1 \times 10^{-6} \text{ F} = 1 \times 10^3 \text{ nF} = 1 \times 10^6 \text{ pF}$
 $1 \text{ nF} = 1 \times 10^{-9} \text{ F} = 1 \times 10^{-3} \mu\text{F} = 1 \times 10^3 \text{ pF}$
 $1 \text{ pF} = 1 \times 10^{-12} \text{ F} = 1 \times 10^{-6} \mu\text{F} = 1 \times 10^{-3} \text{ nF}$
 $\text{F} = \text{Farad}, \mu = \text{micro}, \text{n} = \text{nano}, \text{p} = \text{pico}$

$1000 \mu\text{F} = 1,000,000 \text{ nF} = 10 \times 10^8 \text{ pF}$
 $100 \mu\text{F} = 100,000 \text{ nF} = 10 \times 10^7 \text{ pF}$
 $10 \mu\text{F} = 10,000 \text{ nF} = 10 \times 10^6 \text{ pF}$
 $1 \mu\text{F} = 1,000 \text{ nF} = 10 \times 10^5 \text{ pF}$
 $0.1 \mu\text{F} = 100 \text{ nF} = 10 \times 10^4 \text{ pF}$
 $0.01 \mu\text{F} = 10 \text{ nF} = 10 \times 10^3 \text{ pF}$
 $0.001 \mu\text{F} = 1 \text{ nF} = 10 \times 10^2 \text{ pF}$

Tantalum

Label meaning 1

1st significant figure in μF
 2nd significant figure in μF
 Multiplier (See table)
 Voltage

Color	S.F.	Multiple	Voltage
Black	0	1	10V
Brown	1	10	
Red	2	100	
Orange	3	1000	
Yellow	4		6.3V
Green	5		16V
Blue	6		20V
Violet	7		
Gray	8	0.01	25V
White	9	0.1	3V
Pink			35V

Label meaning 2

Marking	Actual
22	22 μF , 16 V

Mylar (Polyester Film)
Polypropylene
Dipped Mica

Label meaning

Marking	Actual
.001K*	0.001 μF , $\pm 10\%$
104K	0.1 μF , $\pm 10\%$
22J*	0.22 μF , $\pm 5\%$
472K	0.0047 μF , $\pm 10\%$
221J	220 pF, $\pm 5\%$
470J	47 pF, $\pm 5\%$
102J	1000 pF, $\pm 5\%$
103F	0.01 μF , $\pm 1\%$
223F	0.022 μF , $\pm 1\%$

Ceramic Disc Capacitors

22M 1kV: 22 pF $\pm 20\%$, 1000V
Z5U .0033 $\pm 20\%$: 0.033 μF $\pm 20\%$, -56% to +22% variation from +10°C to +85°C
.1Z 100V: 0.1 μF $\pm 20\%$, -20% to +80%
X7R 10K 1 kV: 10 pF $\pm 10\%$, $\pm 15\%$ variation from -55°C to 125°C, 1000V
K5U 474M: 0.47 μF $\pm 20\%$, +22% to -70% variation from +25°C to 85°C
20 $\pm 20\%$ 50V AC 400V DC: 20 pF $\pm 20\%$, 50V AC, 400V DC
Z5P 2200 K: 2200 pF $\pm 10\%$, $\pm 10\%$ variation from +10°C to +85°C
200 nZ 12V: 200 nF -20°C to +80°C, 12V DC
N2200 47 pF $\pm 20\%$: 47 pF $\pm 20\%$, Neg. Temp. Coeff. of 2200 ppm/°C

Label: Varies widely according to manufacturer. Usually given in pF (see multiplier code table) but may be given in μF when there is a decimal before digits. See other tables for temperature and tolerance markings.

Ceramic Disc (European Markings)

Label Meaning

Marking	Actual	Marking	Actual
p68	0.68 pF	22p	22 pF
1p0	1.0 pF	n10	0.1 nF
4p7	4.7 pF	n27	0.27 nF

Label: p = picofarads, n = nanofarads; location of p or n signifies decimal point.

Fixed Ceramic Color Code

1st Digit	2nd Digit	Multiplier	Temp. Coeff.	Tolerance
Black	0	1	$\pm 20\%$	>10pF
Brown	1	10	$\pm 3\%$	<10pF
Red	2	100	$\pm 2\%$	
Orange	3	1000	$\pm 2\%$	
Yellow	4		$\pm 5\%$	0.5pF
Green	5			
Blue	6			
Violet	7			
Gray	8	0.01		0.25pF
White	9	0.1	$\pm 10\%$	1.0pF

Surface Mount Capacitors

Temperature Coefficient
Color Code
Tolerance
1st Digit
2nd Digit
Decimal Point
Multiplier

121K: 120 pF $\pm 10\%$
4R7D: 4.7 pF $\pm 0.5\text{pF}$

Multiplier Code

Numeric Character	Decimal Multiplier (pF)
0	None
1	10
2	100
3	1000
4	10,000

EIA Capacitor Tolerance Codes

Letter	$\leq 10 \text{ pF}$	$\geq 10 \text{ pF}$
B	$\pm 0.1 \text{ pF}$	-
C	$\pm 0.25 \text{ pF}$	-
D	$\pm 0.5 \text{ pF}$	-
E	-	$\pm 25\%$
F	$\pm 1 \text{ pF}$	$\pm 1\%$
G	-	$\pm 2\%$
H	-	$\pm 2.5\%$
J	-	$\pm 5\%$
K	-	$\pm 10\%$
M	-	$\pm 20\%$
P	-	-0 + 100%
S	-	-20 + 50%
W	-	-0 + 200%
X	-	-20 + 40%
Z	-	-20 + 80%

EIA Temperature Characteristic Codes

Minimum temperature	Maximum temperature	Max. cap. change over temp. range
X -55°C	2 +45°C	A $\pm 1.0\%$
Y -35°C	4 +65°C	B $\pm 1.5\%$
Z +10°C	5 +85°C	C $\pm 2.2\%$
	6 +105°C	D $\pm 3.3\%$
	7 +125°C	E $\pm 4.7\%$
		F $\pm 7.5\%$
		P $\pm 10\%$
		R $\pm 15\%$
		S $\pm 22\%$
		T -33% +22%
		U -56% +22%
		V -82% +22%



www.mbsm.pro , Finition Électricité partie 1

written by mahdi miled | 1 September 2018



www.mbsm.pro , Finition Électricité partie 1

Image : <https://www.facebook.com/www.hegay/>

mbsm-dot-pro-electricitee-X.jpg (49 KB)



mbsm-dot-pro-electricitee-X.jpg (57 KB)



mbsm-dot-pro-electricitee-C.jpg (22 KB)



mbsm-dot-pro-electricitee-C.jpg (28 KB)



mbsm-dot-pro-electricitee-D.jpg (29 KB)



PictureS Mbsm Dot Pro : www.mbsm.pro

mbsm-dot-pro-electricitee-D.jpg (37 KB)



mbsm-dot-pro-electricitee-E.jpg (28 KB)



mbsm-dot-pro-electricitee-E.jpg (34 KB)





mbsm-dot-pro-electricitee-F.jpg (42 KB)



mbsm-dot-pro-electricitee-F.jpg (49 KB)



mbsm-dot-pro-electricitee-G.jpg (42 KB)



mbsm-dot-pro-electricitee-G.jpg (49 KB)



mbsm-dot-pro-electricitee-H.jpg (31 KB)



mbsm-dot-pro-electricitee-H.jpg (37 KB)



mbsm-dot-pro-electricitee-I.jpg (28 KB)



mbsm-dot-pro-electricitee-I.jpg (33 KB)



mbsm-dot-pro-electricitee-W.jpg (55 KB)



mbsm-dot-pro-electricitee-W.jpg (63 KB)



mbsm-dot-pro-electricitee-K.jpg (34 KB)



mbsm-dot-pro-electricitee-K.jpg (39 KB)



mbsm-dot-pro-electricitee-M.jpg (29 KB)



mbsm-dot-pro-electricitee-M.jpg (35 KB)



mbsm-dot-pro-electricitee-N.jpg (47 KB)



mbsm-dot-pro-electricitee-N.jpg (54 KB)



mbsm-dot-pro-electricitee-0.jpg (37 KB)



mbsm-dot-pro-electricitee-0.jpg (45 KB)



mbsm-dot-pro-electricitee-P.jpg (42 KB)



mbsm-dot-pro-electricitee-P.jpg (47 KB)



mbsm-dot-pro-electricitee-Q.jpg (58 KB)



mbsm-dot-pro-electricitee-Q.jpg (69 KB)



mbsm-dot-pro-electricitee-R.jpg (50 KB)



mbsm-dot-pro-electricitee-R.jpg (58 KB)



mbsm-dot-pro-electricitee-S.jpg (43 KB)



mbsm-dot-pro-electricitee-S.jpg (52 KB)



mbsm-dot-pro-electricitee-Y.jpg (71 KB)



mbsm-dot-pro-electricitee-Y.jpg (82 KB)



mbsm-dot-pro-electricitee-V.jpg (33 KB)



mbsm-dot-pro-electricitee-V.jpg (41 KB)

